

HÄFELE

# CLOSET & HOME SOLUTIONS 2020



# CONTENTS

---

---

**Introduction**

PAGE

2

---

---

---

**Wardrobe Fittings**

PAGE

7

---

---

---

**Wardrobe Accessories**

PAGE

39

---

---

---

**Omni Track®**

PAGE

59

---

---

---

**HandiWall®**

PAGE

70

---

---

---

**Laundry Room**

PAGE

84

---

---

---

**Pantry**

PAGE

91

---

---

---

**Home Office**

PAGE

97

---

---

---

**Shelving**

PAGE

109

---

---

---

**Decorative Hardware**

PAGE

113

---

---

---

**Loox LED Lighting**

PAGE

147

---



To some, organization merely means “a place to put things” and little more. To us at Häfele, organization — and especially organization done better than anyone else in our industry — is what drives us to make the product selections which both inspire and define spaces. The things we keep are a reflection of one’s personality and Häfele’s organizational and storage products are here to give every precious item its rightful place in your designs.



## SYMPHONY WALL MOUNT ORGANIZER

Aesthetically refined storage. Anywhere. The TAG Hardware Symphony Wall Mount Organizer from Häfele extends less than 5" from the wall which means it can go almost anywhere. Install it in the hallway, entryway, mud room, on the wall behind a closet door or even across from another system where there may not be enough room for shelves or a hanging section.

Symphony can be easily configured to meet evolving needs. Four hooks are available to store items such as coats, shoes, jewelry and hats. These hooks can be moved as seasonal or storage needs change.

Vertical mounts are available in matt aluminum, matt nickel, matt gold and slate finishes in 19", 42 5/8" and 66 1/4" heights, vegan imitation leather bars are available in winter white, oyster and pewter colors in 13 1/2", 23", 35" and 47" widths. Additional matching hooks are available in aluminum, matt nickel, matt gold and slate finishes.

See Symphony on pages 9–11.

# WARDROBE FITTINGS





The modular, stylish ENGAGE system from Häfele is a revolution in closet organization solutions. Beyond traditional elements such as drawers, closet rods and shelves, ENGAGE offers a wide array of hampers, dividers, shoe organizers, folding stations and storage boxes.

This modular, stylish system can be easily used in practically any space. Additionally, most ENGAGE system components come preassembled, allowing for easy and efficient installation.

Available finishes include matt nickel frames with slate fabric, oil-rubbed bronze with beach fabric, matt gold frames with beach fabric and slate frames with slate fabric in standard 18", 24", 30" and 36" widths.

# HOW TO USE TAG HARDWARE'S SYMPHONY IN YOUR DESIGNS

The TAG Hardware Symphony Wall Mount Organizer from Häfele presents a tremendous opportunity for storage in practically any space. Truly its only limits are your creativity. Whether you have a multi-purpose use in mind like coats, shoes and accessories or a more singular purpose like ties, belts or scarves in mind, Symphony is designed to work with you, your needs and your space.



Scan the QR image for design tips and inspiration.



# TAG SYMPHONY

Available in a range of widths and heights for applications in closets, mudrooms, hallways, entryways and bedrooms.

Smaller widths and heights are ideal for partitions or a closet back panel, making the most of the space.

Bold metal finishes and soft imitation leather options offer design versatility.

Comprised of mixed materials, adding texture and dimension to its aesthetic design.

Attaches into drywall or a vertical panel; no studs required.

See coordinating TAG Decorative Hardware on pages 127–130.

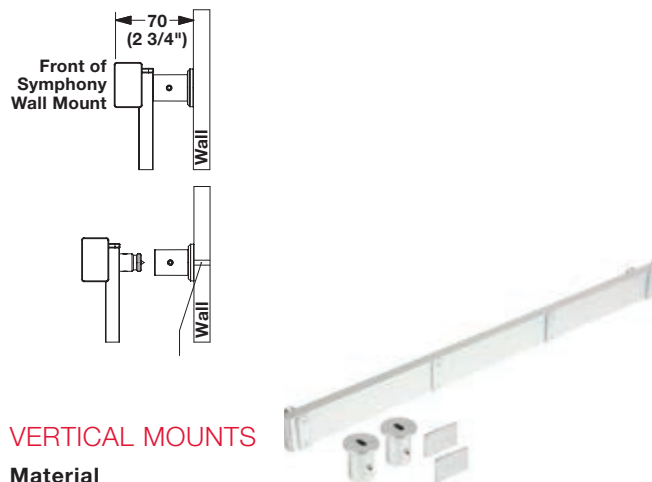

## VERTICAL MOUNTS

**Material**  
Aluminum

Finish	Height	Item No.
matt aluminum	19"	807.72.000
matt nickel	19"	807.72.600
matt gold	19"	807.72.800
slate	19"	807.72.300
matt aluminum	42 5/8"	807.72.001
matt nickel	42 5/8"	807.72.601
matt gold	42 5/8"	807.72.801
slate	42 5/8"	807.72.301
matt aluminum	66 1/4"	807.72.002
matt nickel	66 1/4"	807.72.602
matt gold	66 1/4"	807.72.802
slate	66 1/4"	807.72.302

**Supplied With** 2 vertical mounts, standoffs, end caps for horizontal bars, mounting hardware

**Note** 19" requires 1 set of horizontal bars; 42 5/8" requires 2 sets of horizontal bars; 66 1/4" requires 3 sets of horizontal bars.

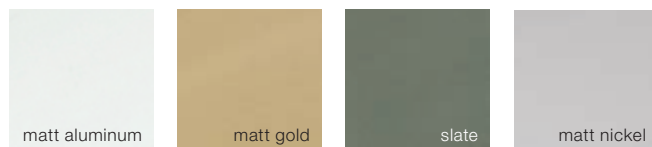

Lengths	Widths			
	342 (13 1/2")	584 (23")	889 (35")	1194 (47")
483 (19")				
1082 (42 5/8")				
1682 (66 1/4")				

## HORIZONTAL BARS

**Material**  
Aluminum, Imitation Leather

Color	Width	Item No.
winter	13 1/2"	807.72.710
pewter	13 1/2"	807.72.510
oyster	13 1/2"	807.72.410
winter	23"	807.72.711
pewter	23"	807.72.511
oyster	23"	807.72.411
winter	35"	807.72.712
pewter	35"	807.72.512
oyster	35"	807.72.412
winter	47"	807.72.713
pewter	47"	807.72.513
oyster	47"	807.72.413

**Supplied With** 4 bars per set





# TAG SYMPHONY

Hooks can be placed anywhere along the horizontal bars and can easily be reconfigured to adapt to changing storage needs.

The hooks project only a short distance from the organizer, allowing it to fit behind doors or in spaces with limited room.

See coordinating TAG Decorative Hardware on pages 127–130.



## TRIPLE HOOK

**Material**  
Aluminum



Finish	Item No.
matt aluminum	807.72.020
matt nickel	807.72.620
matt gold	807.72.820
slate	807.72.320

## COAT HOOK

**Material**  
Aluminum



Finish	Item No.
matt aluminum	807.72.030
matt nickel	807.72.630
matt gold	807.72.830
slate	807.72.330

## LARGE SHOE HOOK

**Material**  
Aluminum



Finish	Item No.
matt aluminum	807.72.041
matt nickel	807.72.641
matt gold	807.72.841
slate	807.72.341

## SMALL SHOE HOOK

**Material**  
Aluminum



Finish	Item No.
matt aluminum	807.72.040
matt nickel	807.72.640
matt gold	807.72.840
slate	807.72.340

# HOW TO GET THE “PERFECT MATCH”

Häfele's entire line of TAG Hardware components perfectly complements one another in any project. No one else offers the closet industry this wide a range of products designed to match one another in form, function and fashion.

Your customers expect the finish of the shoe fence they select will match perfectly the finish of the scarf rack, tie rack or the valet pin. TAG hardware has even extended perfect matching to their knobs and pulls completing a look in closet design as flawlessly coordinated as their favorite outfit.



# TAG ENGAGE

See coordinating TAG Decorative Hardware on pages 127–130.



## PULL-OUT SHELVES

- For use as Jewelry Organizers, Divided Shelves or Folding Stations
- Fabric lined
- Full extension
- Soft closing
- H x D: 2 3/16" x 13 7/8"

### Material

Aluminum, Fabric



Width	matt gold, beach	matt nickel, slate	oil-rubbed bronze, beach	slate, slate
18"	807.77.901	807.77.601	807.77.401	807.78.101
24"	807.77.902	807.77.602	807.77.402	807.78.102
30"	807.77.903	807.77.603	807.77.403	807.78.103
36"	807.77.904	807.77.604	807.77.404	807.78.104

## DRAWER FACE ADAPTERS, OPTIONAL

- Allows a drawer front to be attached to the pull-out frame.
- Drawer front maximum height is 5".
- Conceals the frame and dividers, while adding a place to install a lock
- W x D x H: 2 3/8" x 2 15/16" x 1/8"

### Material

Steel

Finish	Item No.
white	807.77.796
black	807.77.596

### Note

Cannot be used with the pant organizer on page 18.

# TAG ENGAGE

See coordinating TAG Decorative Hardware on pages 127–130.



## JEWELRY ORGANIZERS

- For use with Pull-Out Shelf
- H x D: 15/16" x 12"

### Material

Aluminum

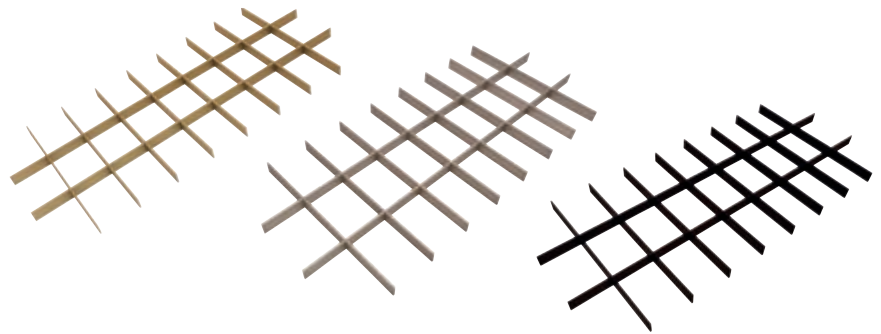

Pull-out shelf	Width	matt gold	matt nickel	oil-rubbed bronze	slate
18"	14 13/16"	807.77.981	807.77.681	807.77.181	807.77.281
24"	20 13/16"	807.77.982	807.77.682	807.77.182	807.77.282
30"	26 13/16"	807.77.983	807.77.683	807.77.183	807.77.283
36"	32 13/16"	807.77.984	807.77.684	807.77.184	807.77.284

## SHELF DIVIDERS WITH CLIPS

- For use with Pull-Out Shelf
- W x D x H: 12 11/16" x 3 1/8" x 1 5/8"

### Material

Aluminum

Finish	Item No.
matt nickel	807.77.199
oil-rubbed bronze	807.77.499

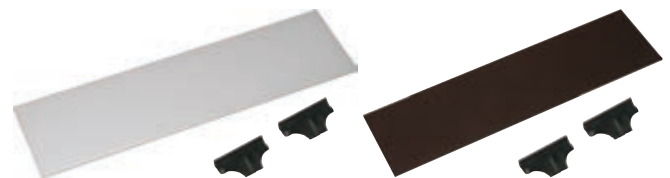

# TAG ENGAGE

See coordinating TAG Decorative Hardware on pages 127–130.



## LINGERIE DRAWERS

- Designed specifically to organize more lingerie in less space
- Fabric dividers allow for completely customizable compartments
- Full extension
- Soft closing
- H x D: 5" x 13 7/8"

### Material

Aluminum, Fabric

Width	# of dividers	matt gold, beach	matt nickel, slate	oil-rubbed bronze, beach	slate, slate
18"	2	807.77.911	807.77.611	807.77.411	807.78.111
24"	3	807.77.912	807.77.612	807.77.412	807.78.112
30"	4	807.77.913	807.77.613	807.77.413	807.78.113
36"	5	807.77.914	807.77.614	807.77.414	807.78.114

## ADDITIONAL LINGERIE DRAWER DIVIDERS

- W x D x H: 13" x 1 5/8" x 2 7/8"

### Material

Fabric

Color	Item No.
slate	807.77.491
beach	807.77.391



# TAG ENGAGE

See coordinating TAG Decorative Hardware on pages 127–130.



## DEEP DRAWERS

- A sophisticated bulk storage solution specifically for the closet
- Fabric dividers allow for completely customizable compartments
- Full extension
- Soft closing
- H x D: 8 15/16" x 13 7/8"

### Material

Aluminum, Fabric

Width	# of dividers	matt gold, beach	matt nickel, slate	oil-rubbed bronze, beach	slate, slate
18"	1	807.77.921	807.77.621	807.77.421	807.78.121
24"	2	807.77.922	807.77.622	807.77.422	807.78.122
30"	3	807.77.923	807.77.623	807.77.423	807.78.123
36"	2	807.77.924	807.77.624	807.77.424	807.78.124

## ADDITIONAL DEEP DRAWER DIVIDERS

- W x D x H: 13" x 1 5/8" x 6 3/4"

### Material

Fabric

Color	Item No.
slate	807.77.492
beach	807.77.392



# TAG ENGAGE

See coordinating TAG Decorative Hardware on pages 127–130.



## LAUNDRY ORGANIZER

- Beautiful, deep, removable laundry bags in 3 widths
- Bags are simple to remove and carry to the laundry room with one hand
- Full extension
- Soft closing
- Frame: H x D: 2 13/16" x 13 7/8"

### Material

Aluminum



Width	Bags	matt nickel/ slate bags	oil-rubbed bronze/ beach bags	matt gold/ beach bags	slate/ slate bags
18"	1 x 18" Bag	807.81.510	807.81.120	807.81.920	807.81.710
24"	2 x 12" Bags	807.81.511	807.81.121	807.81.921	807.81.711
30"	2 x 15" Bags	807.81.512	807.81.122	807.81.922	807.81.712
36"	2 x 18" Bags	807.81.513	807.81.123	807.81.923	807.81.713

### Supplied With

Frame and laundry bags

# TAG ENGAGE

See coordinating TAG Decorative Hardware on pages 127–130.



## PANT ORGANIZER

- Plastic strips allow the pant hangers to glide effortlessly
- Garment clips can be added for hanging skirts or pants by the cuff
- Full extension
- Soft closing
- Frame: H x D: 2 13/16" x 13 7/8"

**Material**

Aluminum

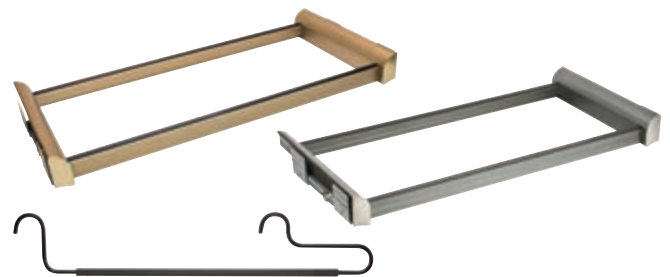

Width	# of hangers	matt nickel	oil-rubbed bronze	matt gold	slate
18"	12	807.81.600	807.81.100	807.81.900	807.81.200
24"	18	807.81.601	807.81.101	807.81.901	807.81.201
30"	24	807.81.602	807.81.102	807.81.902	807.81.202
36"	30	807.81.603	807.81.103	807.81.903	807.81.203

**Supplied With**

Frame hangers

**Note** Cannot be used with the drawer face adapter on page 13.



## LAUNDRY BAGS

- For use with pull-out frame
- H x D: 18 3/4" x 11"

**Material**

Fabric

Width	slate	beach
12"	807.77.440	807.77.340
15"	807.77.441	807.77.341
18"	807.77.442	807.77.342

**Note** Bag width is approximate.

## WIRE PANT HANGERS

- For pant frame organizer

**Material**

Steel



Finish	Item No.
powder-coated, black	805.58.332

## GARMENT CLIP

- Attaches to hangers for skirts, pants, etc.

**Material**

Plastic



Color	Item No.
black	805.58.331



# TAG ENGAGE

See coordinating TAG Decorative Hardware on pages 127–130.



## STORAGE BOXES

- Fits perfectly on the top shelf of an 86" high closet with an 8' ceiling
- H x D: 7 3/8" x 13 1/2"

### Material

Fabric



Width	slate	beach
14 1/2"	807.77.460	807.77.360
17 1/2"	807.77.461	807.77.361
23 1/2"	807.77.462	807.77.362

# TAG ENGAGE

See coordinating TAG Decorative Hardware on pages 127–130.

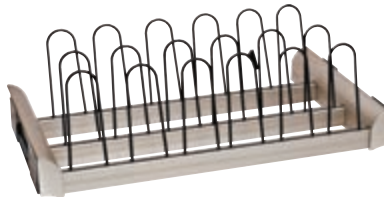

## SHOE ORGANIZERS

- Perfect solution to utilize closet depth and allow easy access
- Front clips convert the first row into sandal storage
- H x D: 7 1/2" x 13 7/8"

### Material

Aluminum

Width	# of clips	matt gold	matt nickel	oil-rubbed bronze	slate
18"	4	807.77.971	807.77.671	807.77.171	807.77.271
24"	6	807.77.972	807.77.672	807.77.172	807.77.272
30"	8	807.77.973	807.77.673	807.77.173	807.77.273
36"	10	807.77.974	807.77.674	807.77.174	807.77.274

# TAG SIGNATURE COLLECTION

See coordinating TAG Decorative Hardware on pages 127–130.



## WARDROBE TUBES WITH SUPPORTS

- Protective cap reduces noise and prevents scratching
- D x H: 3/4" x 1 1/4"

### Material

Tube: Aluminum, anodized/Plastic cap

End supports: Zinc-plated

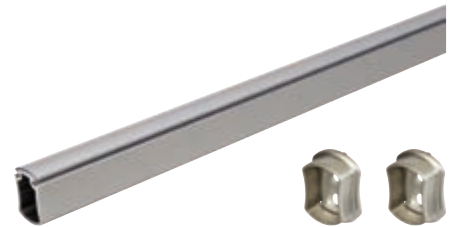

Length	Finish/Cap					
	matt gold/clear	polished chrome /clear	matt aluminum /clear	matt nickel /clear	dark oil-rubbed bronze /black	slate/black
17 3/4"	801.78.991	801.78.291	801.78.491	801.78.691	801.78.191	801.78.391
23 3/4"	801.78.992	801.78.292	801.78.492	801.78.692	801.78.192	801.78.392
29 3/4"	801.78.993	801.78.293	801.78.493	801.78.693	801.78.193	801.78.393
35 3/4"	801.78.994	801.78.294	801.78.494	801.78.694	801.78.194	801.78.394
47 15/16"	801.78.995	801.78.295	801.78.495	801.78.695	801.78.195	801.78.395

# TAG SIGNATURE COLLECTION

See coordinating TAG Decorative Hardware on pages 127–130.



## WARDROBE TUBES

- Protective cap reduces noise and prevents scratching
- Tube can be mounted to the side panels or suspended from a shelf
- D x H x L:  
3/4" x 1 1/4" x 8'

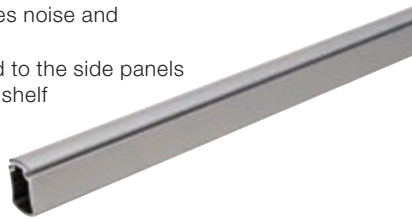

**Material**  
Aluminum/Plastic cap

Finish/Cap	Item No.
matt gold/clear	801.78.912
polished chrome/clear	801.78.212
matt aluminum/clear	801.78.412
matt nickel/clear	801.78.612
oil-rubbed bronze/black	801.78.112
slate/black	801.78.312

## SUSPENDED SUPPORTS

- W x H: 1 1/4" x 3 5/8"



**Material**  
Zinc

Finish	Item No.
matt gold	803.64.900
polished chrome	803.64.200
matt aluminum	803.64.000
matt nickel	803.64.600
oil-rubbed bronze	803.64.100
slate	803.64.300

## CENTER SUSPENDED SUPPORTS

- W x H: 1 1/4" x 3 5/8"



**Material**  
Zinc

Finish	Item No.
matt gold	802.13.900
polished chrome	802.13.200
matt aluminum	802.13.000
matt nickel	802.13.600
oil-rubbed bronze	802.13.100
slate	802.13.300

## END SUPPORTS

- W x H: 1 1/4" x 1 3/4"



**Material**  
Zinc

Finish	Item No.
matt gold	803.39.950
polished chrome	803.39.250
matt aluminum	803.39.450
matt nickel	803.64.650
oil-rubbed bronze	803.39.150
slate	803.39.750

# TAG SYNERGY ELITE

See coordinating TAG Decorative Hardware on pages 127–130.



## WARDROBE TUBES WITH SUPPORTS

- Round with protective insert on top
- Ø: 1 5/16"

### Material

Tube: Aluminum, anodized/Plastic insert  
End supports: Zinc-plated

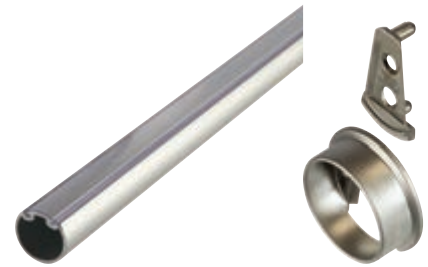

Length	Finish/Insert					
	matt gold/clear	polished chrome /clear	matt aluminum /clear	matt nickel /clear	dark oil-rubbed bronze /black	slate/black
17 3/4"	801.42.055	801.42.255	801.42.465	801.42.655	801.42.155	801.42.355
23 3/4"	801.42.056	801.42.256	801.42.466	801.42.656	801.42.156	801.42.356
29 3/4"	801.42.057	801.42.257	801.42.467	801.42.657	801.42.157	801.42.357
35 3/4"	801.42.058	801.42.258	801.42.468	801.42.658	801.42.158	801.42.358
47 15/16"	801.42.059	801.42.259	801.42.469	801.42.659	801.42.159	801.42.359

### Note

See lighted wardrobe tube on page 149.

# TAG SYNERGY ELITE

See coordinating TAG Decorative Hardware on pages 127–130.



## WARDROBE TUBES

- Round with protective insert on top
- Ø x L: 1 5/16" x 8'

### Material

Aluminum, anodized/Plastic insert



Finish/Insert	Item No.
matt gold/clear	801.42.040
polished chrome/clear	801.42.240
matt aluminum/clear	801.42.440
matt nickel/clear	801.42.640
oil-rubbed bronze/black	801.42.140
slate/black	801.42.340

## END SUPPORTS

- Two-part design allows the support to fully surround the tube
- 32 mm spacing with an additional screw hole for side panel mounting

### Material

Zinc-plated



Finish	Item No.
matt gold	803.39.910
polished chrome	803.39.210
matt aluminum	803.39.410
matt nickel	803.39.610
dark oil-rubbed bronze	803.39.110
slate	803.39.710

## WARDROBE TUBE CENTER SUPPORT

- Surface mount
- For Ø33 mm (1 5/16") tube

### Material

Zinc die-cast



Finish	Item No.
matt gold	802.06.067
polished chrome	802.06.267
matt aluminum	802.06.367
matt nickel	802.06.667
dark oil-rubbed bronze	802.06.167
slate	802.06.467

### Supplied With

Screws

# TAG SYNERGY ELITE

See coordinating TAG Decorative Hardware on pages 127–130.



## TIE RACKS WITH SLIDES

- Full extension
- W x H: 2 9/16" x 2 5/8"

### Material

Aluminum, anodized/Zinc

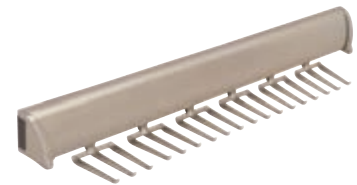

Finish	15 hook; length: 11 7/8"	18 hook; length: 13 7/8"	24 hook; length: 17 15/16"
matt gold	807.67.901	807.67.904	807.67.905
polished chrome	807.67.201	807.67.203	807.67.205
matt aluminum/chrome	807.67.401	807.67.403	807.67.405
matt nickel	807.67.601	807.67.603	807.67.605
dark oil-rubbed bronze	807.67.101	807.67.103	807.67.105
slate	807.67.301	807.67.303	807.67.305

## BELT RACKS WITH SLIDES

- Full extension
- W x H: 1 5/8" x 2 13/16"

### Material

Aluminum, anodized/Zinc



Finish	5 hook; length: 11 7/8"	6 hook; length: 13 7/8"	8 hook; length: 17 15/16"
matt gold	807.67.911	807.67.913	807.67.915
polished chrome	807.67.211	807.67.213	807.67.215
matt aluminum/chrome	807.67.411	807.67.413	807.67.415
matt nickel	807.67.611	807.67.613	807.67.615
dark oil-rubbed bronze	807.67.111	807.67.113	807.67.115
slate	807.67.311	807.67.313	807.67.315

# TAG SYNERGY ELITE

See coordinating TAG Decorative Hardware on pages 127–130.



## SCARF RACKS WITH SLIDES

- Full extension
- W x H: 2 3/16" x 2 9/16"

### Material

Aluminum, anodized/Zinc



Finish	5 hook; length: 11 7/8"	6 hook; length: 13 7/8"	8 hook; length: 17 15/16"
matt gold	807.67.921	807.67.923	807.67.925
polished chrome	807.67.221	807.67.223	807.67.225
matt aluminum/chrome	807.67.421	807.67.423	807.67.425
matt nickel	807.67.621	807.67.623	807.67.625
dark oil-rubbed bronze	807.67.121	807.67.123	807.67.125
slate	807.67.321	807.67.323	807.67.325

## FIXED ACCESSORY HOOKS

- W x H: 1 5/8" x 2 13/16"

### Material

Aluminum, anodized/Zinc



Finish	6 hook length: 15 1/4"	8 hook length: 19 1/4"
matt gold	807.67.983	807.67.985
polished chrome	807.67.283	807.67.285
matt aluminum/chrome	807.67.483	807.67.485
matt nickel	807.67.683	807.67.685
dark oil-rubbed bronze	807.67.183	807.67.185
slate	807.67.383	807.67.385



# TAG SYNERGY ELITE

See coordinating TAG Decorative Hardware on pages 127–130.



## VALETS

- Mounts to the side panel
- Weight capacity: 30 lbs. in vertical position
- W x H: 15/16" x 15/16"

### Material

Aluminum, anodized



Finish	Length: 11 3/4"; Extension: 7 9/16"	Length: 14 1/8"; Extension: 9 9/16"
matt gold	808.71.001	808.71.003
polished chrome	808.71.201	808.71.203
matt aluminum/chrome	808.71.401	808.71.403
matt nickel	808.71.601	808.71.603
dark oil-rubbed bronze	808.71.101	808.71.103
slate	808.71.301	808.71.303

## VALET PINS

- Retracts into the partition
- Weight capacity: 5 lbs.
- Length: 4"
- Extension: 1 3/4"



### Material

Aluminum

Finish	Item No.
matt gold	808.72.900
chrome	808.72.200
matt aluminum	808.72.000
matt nickel	808.72.600
oil-rubbed bronze	808.72.100
slate	808.72.300

# TAG SYNERGY ELITE

See coordinating TAG Decorative Hardware on pages 127–130.



## SHOE FENCE SET

- For shelving, available in standard widths
- Width can be reduced by sliding the end post off and cutting aluminum rail, reattach post by tapping on with rubber mallet
- Center post slides back and forth for easy positioning, supplied for lengths over 23"
- Horizontal rails are two sided, one being smooth and other textured to match other Synergy Elite items



### Material

Aluminum

Length	polished chrome	matt aluminum; chrome post	matt nickel	matt gold; polished post	dark oil-rubbed bronze	slate
11"	547.52.221	547.52.421	547.52.621	547.52.921	547.52.121	547.52.321
17"	547.52.222	547.52.422	547.52.622	547.52.922	547.52.122	547.52.322
23"	547.52.223	547.52.423	547.52.623	547.52.923	547.52.123	547.52.323
29"	547.52.224	547.52.424	547.52.624	547.52.924	547.52.124	547.52.324
35"	547.52.226	547.52.426	547.52.626	547.52.926	547.52.126	547.52.326

### Supplied With

Mounting hardware  
Bar  
2 posts



## SHOE FENCE BAR

- Bar can be customized to fit the shelf of your choice
- Perfect for framing shelves, pull-out trays or creating your own shoe fence
- Use the versatile corner posts to create unified corners on L-shaped shoe shelves, frame pull-out shelves or create your own unique design
- Length: 93"

### Material

Aluminum

Finish	Item No.
polished chrome	547.52.240
matt aluminum	547.52.040
matt nickel	547.52.640
matt gold	547.52.940
dark oil-rubbed bronze	547.52.140
slate	547.52.340



## POSTS FOR SHOE FENCE

- Corner posts provide a sleek solution to framing pull-out shelves, which can be used to store shoes or display your favorite items
- Ideal for framing floating angled shoe shelves
- Perfect for L-shaped shelves, providing a unified corner

### Material

Aluminum

Finish	Center	End	Corner
chrome	547.52.280	547.52.290	547.52.299
matt nickel	547.52.680	547.52.690	547.52.699
matt gold	547.52.980	547.52.990	547.52.999
oil-rubbed bronze	547.52.180	547.52.190	547.52.199
slate	547.52.380	547.52.390	547.52.399

Supplied With Mounting hardware

# TAG SYNERGY ELITE

Easy to use, pull out and rotate for full viewing.  
 Mounts with four screws.  
 Slides have detent in and out to hold mirror in place.  
 Ideal for spaces where installation is required on the outside of a panel and rotated inwards.  
 Mirror extends 6" from the front edge of the closet allowing up to 345° rotation.  
 Provides great viewing angles from almost anywhere in the closet.  
 See coordinating TAG Decorative Hardware on pages 127–130.



## FULL ROTATION MIRRORS

- Length: 13 1/8"
- Width: 35" mirror - 1 5/16"; 47" mirror - 1 1/2"

### Material

Aluminum

Finish	Height: 35"	Height: 47 3/8"
matt aluminum	805.73.021	805.73.022
dark oil-rubbed bronze	805.73.121	805.73.122
matt gold	805.73.921	805.73.922
matt nickel	805.73.621	805.73.622
slate	805.73.321	805.73.322

### Note

35" mirrors allow for installation above jewelry drawers, inside upper hanging sections or anywhere you're a little short on space.

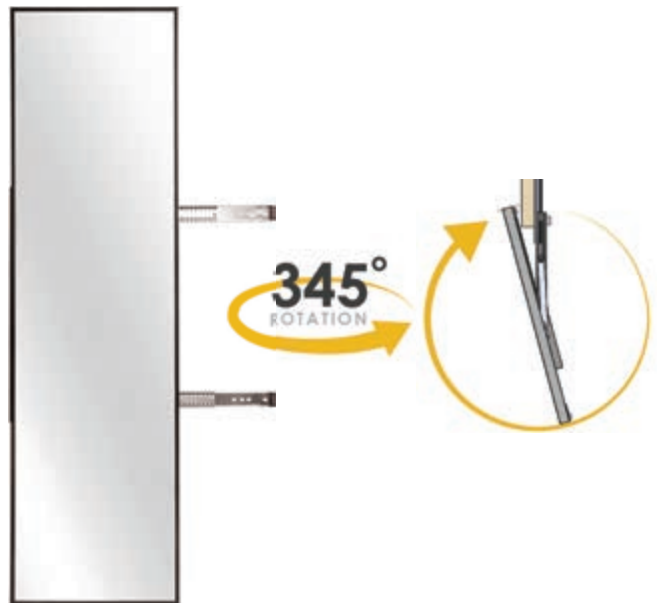

## FIXED MIRRORS

- Slim, full frame mirror features a low profile design
- Perfect for unused wall space or behind a door
- Style and finish coordinate perfectly with all Synergy Elite and Synergy accessories
- W x D: 13 1/8" x 5/8"

### Material

Aluminum

Finish	Height: 35"	Height: 47 3/8"
matt aluminum	805.73.011	805.72.030
dark oil-rubbed bronze	805.73.111	805.72.130
matt gold	805.73.911	805.72.930
matt nickel	805.73.611	805.72.630
slate	805.73.311	805.72.330

### Supplied With

Locking and installation hardware



# TAG SYNERGY ELITE

## CLEAT SYSTEM

Hooks are used on customer supplied boards.  
See coordinating TAG Decorative Hardware on pages 127–130.

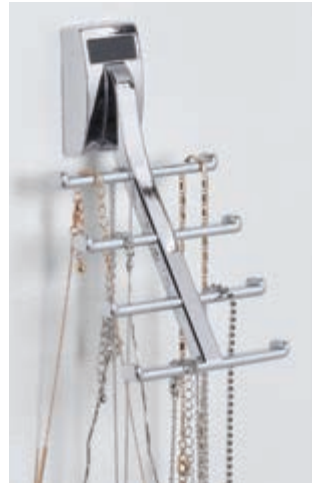

## TIE HOOKS

- Stores 8 ties
- L x W x H: 3 3/4" x 2 3/8" x 5 1/4"

**Material**  
Zinc



Finish	Item No.
matt gold	807.69.901
polished chrome	807.69.200
matt aluminum	807.69.000
matt nickel	807.69.600
oil-rubbed bronze	807.69.100
slate	807.69.370

## WATERFALL HOOKS

- Each hook holds 3 coat hangers
- L x W x H: 3 3/4" x 1/2" x 6 1/2"

**Material**  
Zinc



Finish	Item No.
matt gold	807.69.960
polished chrome	807.69.260
matt aluminum	807.69.060
matt nickel	807.69.660
dark oil-rubbed bronze	807.69.160
slate	807.69.360

# TAG SYNERGY ELITE

## CLEAT SYSTEM

Hooks are used on customer supplied boards.  
See coordinating TAG Decorative Hardware on pages 127–130.



### BELT HOOKS

- Stores 5 belts
- L x W x H: 3 1/16" x 3 1/8" x 5 1/8"



**Material**  
Zinc

Finish	Item No.
matt gold	807.69.920
polished chrome	807.69.220
matt aluminum	807.69.020
matt nickel	807.69.620
oil-rubbed bronze	807.69.120
slate	807.69.320

### COAT HOOKS

- L x W x H: 1 1/2" x 3 5/8" x 6 1/4"
- Compact Hooks: L x W x H: 1 1/16" x 2 3/4" x 4 1/2"



**Material**  
Zinc

Finish	Coat Hook	Compact Coat Hook
matt gold	807.69.930	807.69.931
polished chrome	807.69.230	807.69.231
matt aluminum	807.69.030	807.69.031
matt nickel	807.69.630	807.69.631
oil-rubbed bronze	807.69.130	807.69.131
slate	807.69.330	807.69.331

### DOUBLE HOOKS

- L x W x H: 3 1/2" x 2 1/2" x 2 5/8"



**Material**  
Zinc

Finish	Item No.
matt gold	807.69.940
polished chrome	807.69.240
matt aluminum	807.69.040
matt nickel	807.69.640
oil-rubbed bronze	807.69.140
slate	807.69.340

### BROOM HOOKS

- For long handle items
- L x W x H: 1 3/8" x 7/8" x 4 5/16"



**Material**  
Zinc

Finish	Item No.
matt gold	807.69.950
polished chrome	807.69.250
matt aluminum	807.69.050
matt nickel	807.69.650
oil-rubbed bronze	807.69.150
slate	807.69.350

# TAG SYNERGY

See coordinating TAG Decorative Hardware on pages 127–130.



## WARDROBE TUBES WITH SUPPORTS, ROUND

- Ø: 1 5/16"

### Material

Aluminum, anodized



Length	polished chrome	matt aluminum	matt nickel	dark oil-rubbed bronze
17 3/4"	801.42.235	801.42.935	801.42.635	801.42.135
23 3/4"	801.42.236	801.42.936	801.42.636	801.42.136
29 3/4"	801.42.237	801.42.937	801.42.637	801.42.137
35 3/4"	801.42.238	801.42.938	801.42.638	801.42.138
47 15/16"	801.42.234	801.42.934	801.42.634	801.42.134

## WARDROBE TUBES, ROUND

- Ø x L: 1 5/16" x 8'

### Material

Aluminum, anodized or powder-coated



Finish	Item No.
polished chrome	801.42.200
matt aluminum	801.42.900
matt nickel	801.42.600
dark oil-rubbed bronze	801.42.100
white powder-coated	801.42.710

## END SUPPORTS

- 1 1/4" spacing with an additional screw hole for side panel mounting

### Material

Zinc-plated



Finish	Item No.
polished chrome	803.56.200
matt aluminum	803.56.900
matt nickel	803.56.600
dark oil-rubbed bronze	803.56.100
white powder-coated	803.56.710

## CENTER SUPPORTS

- Surface mount; fits Ø1 5/16" tube

### Material

Zinc die-cast



Finish	Item No.
polished chrome	802.06.267
matt aluminum	802.06.367
matt nickel	802.06.667
dark oil-rubbed bronze	802.06.167

# TAG SYNERGY

See coordinating TAG Decorative Hardware on pages 127–130.



## TIE RACKS WITH SLIDES, 3/4 EXTENSION

- W x H: 2 3/16" x 1 11/16"

### Material

Aluminum, anodized or powder-coated

Finish	20 hook length: 14 1/8"	17 hook length: 11 15/16"
polished chrome	807.54.233	807.54.232
matt aluminum	807.54.933	807.54.932
matt nickel	807.54.633	807.54.632
dark oil-rubbed bronze	807.54.133	807.54.132
white powder-coated	807.54.773	807.54.772



## BELT RACKS WITH SLIDES, 3/4 EXTENSION

- W x H: 2 3/16" x 1 11/16"

### Material

Aluminum, anodized or powder-coated

Finish	6 hook length: 14 1/8"	5 hook length: 11 15/16"
polished chrome	807.54.231	807.54.230
matt aluminum	807.54.931	807.54.930
matt nickel	807.54.631	807.54.630
dark oil-rubbed bronze	807.54.131	807.54.130
white powder-coated	807.54.771	807.54.770



# TAG SYNERGY

See coordinating TAG Decorative Hardware on pages 127–130.



## SCARF RACKS WITH SLIDES

- 3/4 extension with 6 hooks
- L x W x H: 14 1/8" 2 3/8" x 1 11/16"

**Material**

Aluminum, anodized



Finish	Item No.
polished chrome	807.54.234
matt aluminum	807.54.934
matt nickel	807.54.634
dark oil-rubbed bronze	807.54.134

## VALETS

- Mounts to the cabinet side panel
- Weight capacity: 30 lbs. in vertical position
- W x H: 1 1/16" x 1 7/8"

**Material**

Aluminum, anodized or powder-coated



Finish	Length: 14 1/4"; Extension: 9 9/16"	Length: 11 13/16"; Extension: 7 9/16"
polished chrome	808.70.231	808.70.230
matt aluminum	808.70.931	808.70.930
matt nickel	808.70.631	808.70.630
dark oil-rubbed bronze	808.70.131	808.70.130
white powder-coated	808.70.771	808.70.770



# TAG SYNERGY

See coordinating TAG Decorative Hardware on pages 127–130.



## PANT RACKS

- Full extension
- D x H: 14" x 2 5/16"

### Material

Aluminum, anodized



Length	# of Hangers	polished chrome	matt aluminum	matt nickel	dark oil-rubbed bronze
18"	12	805.58.231	805.58.931	805.58.631	805.58.131
24"	18	805.58.233	805.58.933	805.58.633	805.58.133
30"	24	805.58.235	805.58.935	805.58.635	805.58.135

## WIRE PANT HANGERS

- For pant rack

### Material

Steel



Finish	Item No.
powder-coated, black	805.58.332

**Supplied With** 18 hangers

## GARMENT CLIP, OPTIONAL

- Attaches to above hangers for skirts, pants, etc.
- 2 required per hanger

### Material

Plastic



Color	Item No.
black	805.58.331

## SHOE RAILS

- Requires bracket to the right
- Ø x L: 3/4" x 36"

### Material

Aluminum, anodized



Finish	Item No.
polished chrome	805.87.210
matt aluminum	805.87.910

## SHOE RAIL BRACKET

- With 5 mm press-in dowels

### Material

Plastic



Color	Item No.
black	805.87.993

# TAG SYNERGY

See coordinating TAG Decorative Hardware on pages 127–130.



## PULL-OUT HAMPERS

- Full extension with removable bags
- D x H: 14" x 21 1/2"

### Material/Color

Aluminum, anodized/Nylon, black

Width	Bags	polished chrome	matt aluminum	matt nickel	dark oil-rubbed bronze
18"	1 large	807.52.231	807.52.931	807.52.631	807.52.131
24"	2 small	807.52.233	807.52.933	807.52.633	807.52.133
30"	1 large & 1 small	807.52.235	807.52.935	807.52.635	807.52.135

# TAG SYNERGY

See coordinating TAG Decorative Hardware on pages 127–130.



## TILT-OUT HAMPERS

- Screws to back of door
- Removable bags
- D x H: 13 9/16" x 23 5/8"

### Material/Color

Steel, epoxy-coated, black/Nylon, black

Width	Bags	Item No.
16 1/4"	1 large	547.43.301
22 1/4"	2 small	547.43.303
28 1/8"	1 large & 1 small	547.43.305

### Note

Flap Stay Hamper Kit, see page 46.



## REPLACEMENT BAGS

- Without handles

### Material/Color

Nylon, black

W x D x H	Item No.
10 1/2" x 12 1/16" x 19 1/16"	547.43.390
14 15/16" x 12 1/16" x 19 1/16"	547.43.391

## REPLACEMENT HANDLES

- Without bags

### Material

Steel and Rubber



Color	Item No.
black	547.43.399

### Supplied with

2 handles

OMNI TRACK®





One system with exactly as much versatility, function and personality as you need to conquer clutter in practically any space. That means all the stuff in your garage, craft room, mud room, closet and home or commercial office has met its match. All TAG Hardware's Omni Track from Häfele needs is a wall and your desire to organize. Extended lengths of cut-to-fit track with custom hooks and shelves combine to bring order to the chaos.

# OMNI TRACK<sup>®</sup> READY PACK KITS

## READY PACK TRACK KIT - 97"

	Packing	Item No.
	1 set	792.00.002

**Consisting of:**

	Qty.	Item No.
Wall Track 97"	2 pcs.	792.00.000
Plastic Edge Profile	8 pcs.	792.00.320
Truss Head Screw #10 X 2 1/2"	100 pcs.	792.01.993
Installation Nail	1 pkg. (50 pcs.)	792.01.998

**Note**

Accessories sold separately, not included in track kits.

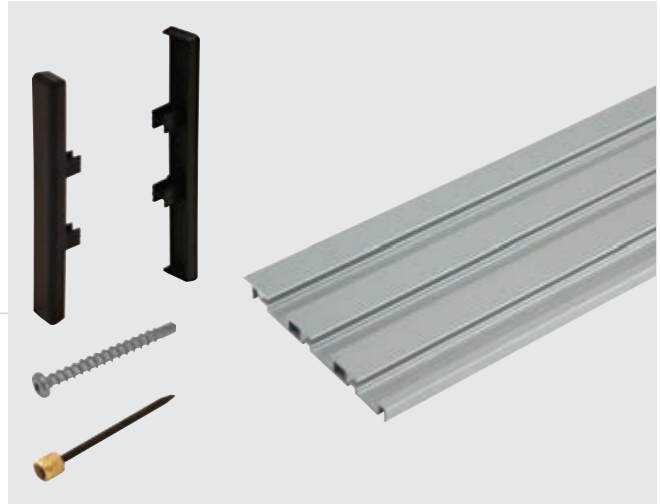

## READY PACK TRACK KIT - 48"

	Packing	Item No.
	1 set	792.00.001

**Consisting of:**

	Qty.	Item No.
Wall Track 48"	4 pcs.	792.00.000
Plastic Edge Profile	8 pcs.	792.00.320
Truss Head Screw #10 X 2 1/2"	100 pcs.	792.01.993
Installation Nail	1 pkg. (50 pcs.)	792.01.998
Track Joiners	4 pcs.	792.00.310

**Note**

Accessories sold separately, not included in track kits.



# OMNI TRACK® READY PACK KITS

## READY PACK LAWN/GARDEN KIT

	Packing	Item No.
	1 set	792.02.241

**Consisting of:**

		Qty.	Item No.
<b>A</b>	Heavy Duty Hose Hook	1 pc.	792.02.202
<b>B</b>	Heavy Duty Utility Hook	2 pcs.	792.02.203
<b>F</b>	Heavy Duty Garden Tool Hook	4 pcs.	792.02.200
<b>N</b>	Hand Tool Hook	2 pcs.	792.02.255
<b>Q</b>	Large Storage Bin	1 pc.	792.02.382
	Cover Cap for Heavy Duty Hooks	10 pcs.	792.02.349
	Cover Cap for Small Hooks	2 pcs.	792.02.399

**Note**

Track not included, see track kits page 61.

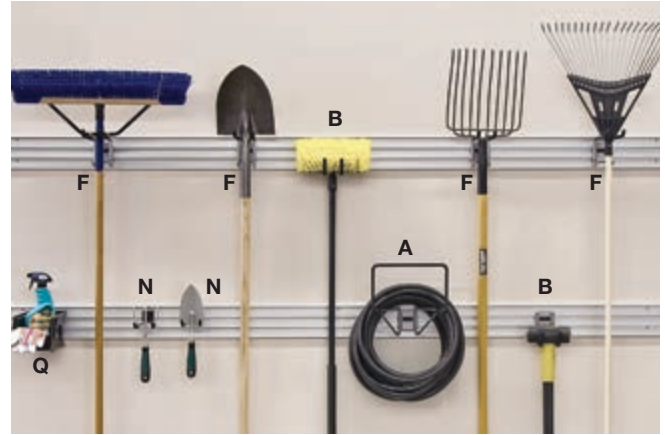

## READY PACK SPORTS KIT

	Packing	Item No.
	1 set	792.02.000

**Consisting of:**

		Qty.	Item No.
<b>B</b>	Heavy Duty Utility Hook	2 pcs.	792.02.203
<b>C</b>	Heavy Duty Activity Hook	2 pcs.	792.02.004
<b>D</b>	Heavy Duty 16" Utility Hook	1 pc.	792.02.005
<b>G</b>	Heavy Duty Bike Hook	2 pcs.	792.02.201
<b>Q</b>	Large Storage Bin	2 pcs.	792.02.382
	Cover Cap for Heavy Duty Hooks	10 pcs.	792.02.349

**Note**

Track not included, see track kits page 61.

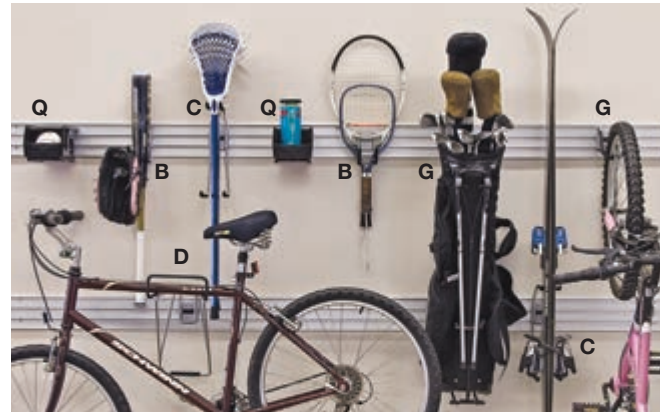

## READY PACK WORK/CRAFT BENCH KIT

	Packing	Item No.
	1 set	792.02.240

**Consisting of:**

		Qty.	Item No.
<b>H</b>	Plier Hook	3 pcs.	792.02.250
<b>I</b>	Wrench Hook	3 pcs.	792.02.251
<b>J</b>	Screwdriver Hook	3 pcs.	792.02.252
<b>L</b>	Single Hook	3 pcs.	792.02.253
<b>M</b>	Paper Organizer Set	1 set	792.02.254
<b>N</b>	Hand Tool Hook	2 pcs.	792.02.255
<b>O</b>	Small Storage Bin	2 pcs.	792.02.380
<b>P</b>	Medium Storage Bin	2 pcs.	792.02.381
<b>Q</b>	Large Storage Bin	2 pcs.	792.02.382
	Cover Cap for Small Hook	17 pcs.	792.02.399
	Aluminum Edge Profile with Application Tape	2 pcs.	-

**Note**

Track not included, see track kits page 61.

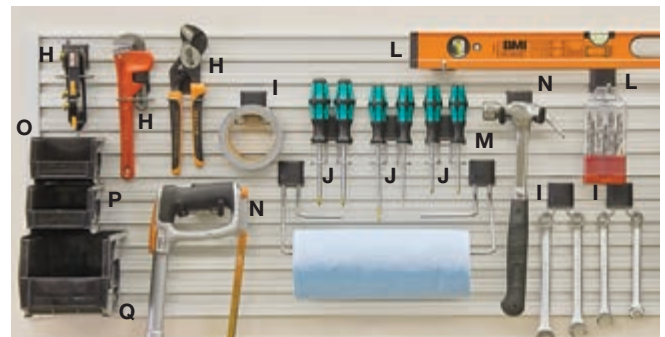

# OMNI TRACK®



## WALL TRACK

- For use with hooks, bins and baskets
- Tracks can be seamlessly overlapped to create a panel
- L x H x D: 97" x 4 3/4" x 1/2"



**Material**

Aluminum

Finish	Item No.
matt aluminum	792.00.000

## END CAPS

- Covers a single wall track end for a finished look
- Includes right and left profile
- W x H: 1/2" x 5"



**Material**

Plastic

Color	Item No.
black	792.00.320

## EDGE PROFILE

- Covers wall track ends for a finished look
- Attaches with mounting tape 792.01.994
- L x H x D: 96" x 15/16" x 1/2"



**Material**

Aluminum

Finish	Item No.
matt aluminum	792.01.000

## SHELF STIFFENER

- Adds strength and protection to panel edges
- Taps on with a rubber mallet
- L x H x D: 96" x 13/16" x 15/16"



**Material**

Aluminum

Finish	Item No.
matt aluminum	792.01.030



# OMNI TRACK®

Hooks are used with wall track 792.00.000.

**Note**

Cover cap 792.02.349 is required.

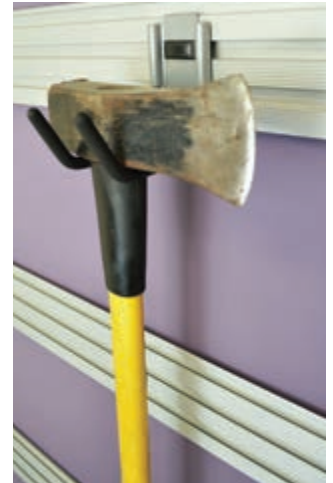

## 16" UTILITY HOOK

- Horizontal storage for bicycles; use two hooks for long items
- L x W x H: 15 7/8" x 8 1/4" x 16 3/16"



**Material**

Steel/Rubber-Coated

Finish/Color	Item No.
matt aluminum/black	792.02.005

## HOSE HOOK

- Stores garden hoses, ropes and extension cords
- L x W x H: 7 7/16" x 10 13/16" x 10 13/16"



**Material**

Steel/Rubber-Coated

Finish/Color	Item No.
matt aluminum/black	792.02.202

## UTILITY HOOK

- For general use
- L x W x H: 5 13/16" x 2 13/16" x 5 1/16"



**Material**

Steel/Rubber-Coated

Finish/Color	Item No.
matt aluminum/black	792.02.203

## GARDEN TOOL HOOK

- Hold multiple long handled garden tools
- L x W x H: 9 1/4" x 2 5/16" x 4 5/16"



**Material**

Steel/Rubber-Coated

Finish/Color	Item No.
matt aluminum/black	792.02.200

## 14" UTILITY HOOK

- Horizontal storage for bicycles, garden tools or beach chairs
- L x W x H: 14 3/8" x 2 13/16" x 5 1/4"



**Material**

Steel/Rubber-Coated

Finish/Color	Item No.
matt aluminum/black	792.02.070

## COVER CAP

- W x D x H: 1 1/2" x 1/2" x 11/16"



**Material**

Plastic

Color	Item No.
black	792.02.349

# OMNI TRACK®

Hooks are used with wall track 792.00.000.

**Note**

Cover cap 792.02.349 is required.



## ACTIVITY HOOK

- Stores skis, snowboards, baseball bats, lacrosse sticks and rackets
- L x W x H: 9 1/2" x 3" x 12 11/16"

**Material**

Steel/Rubber-Coated



Finish/Color	Item No.
matt aluminum/black	792.02.004

## FISHING ROD HOOK

- Vertically stores one fishing rod
- L x W x H: 5" x 2 13/16" x 15 1/4"

**Material**

Steel/Rubber-Coated



Finish/Color	Item No.
matt aluminum/black	792.02.006

## BIKE HOOK

- Vertical storage of one bicycle, golf bags or leaf blowers
- L x W x H: 5 9/16" x 3 1/2" x 4 15/16"

**Material**

Steel/Rubber-Coated



Finish/Color	Item No.
matt aluminum/black	792.02.201

## SMALL SHELF BRACKET

- For use with a 3/4" thick shelf with 10" maximum depth
- Maximum weight capacity: 50 lbs.
- L x W x H: 2" x 2 1/2" x 3 5/8"

**Material**

Aluminum



Finish	Item No.
matt aluminum	792.02.060

## COVER CAP

- W x D x H: 1 1/2" x 1/2" x 11/16"

**Material**

Plastic



Color	Item No.
black	792.02.349

# OMNI TRACK®

Hooks are used with wall track 792.00.000.

**Note**

Cover cap 792.02.399 is required, see page 67.



## SCREWDRIVER HOOK

- Organizes two screwdrivers and other small tools
- L x W x H: 1 9/16" x 2 11/16" x 3 3/16"



**Material**  
Steel

Finish	Item No.
matt aluminum	792.02.252

## SINGLE HOOK

- For general use
- L x W x H: 5 3/8" x 1 1/2" x 1 13/16"



**Material**  
Steel

Finish	Item No.
matt aluminum	792.02.253

## HAND TOOL HOOK

- Organizes hammers and other small tools
- L x W x H: 5 1/8" x 2 5/8" x 1 15/16"



**Material**  
Steel/Rubber-Coated

Finish/Color	Item No.
matt aluminum/black	792.02.255

## PAPER ORGANIZER

- Organizes rolls of wrapping paper or paper towels
- L x W x H (one side): 6 1/4" x 4 11/16" x 5 5/8"

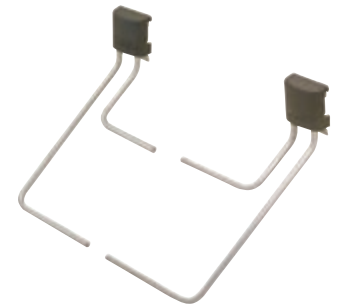

**Material**  
Steel

Finish	Item No.
matt aluminum	792.02.254

## WRENCH HOOK

- Organizes two wrenches and other small tools
- L x W x H: 1 3/8" x 2 1/8" x 2"



**Material**  
Steel

Finish	Item No.
matt aluminum	792.02.251

## PLIERS HOOK

- Organizes pliers and other small tools
- L x W x H: 1 5/16" x 2 7/16" x 2"



**Material**  
Steel

Finish	Item No.
matt aluminum	792.02.250

# OMNI TRACK®

Hooks and storage bins are used with wall track 792.00.000.

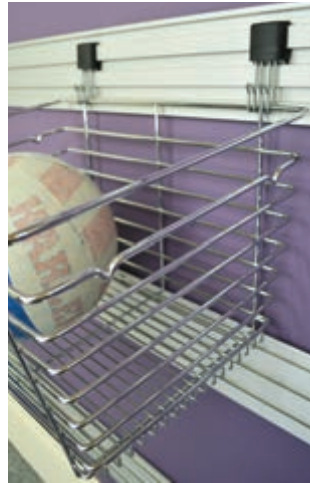

## BASKET HOOK

- For use with closet baskets, 547.xx.xxx, see page 43.
- L x W x H: 7/8" x 1 1/2" x 3 1/2"

**Material**  
Steel



Finish	Item No.
matt aluminum	792.02.007

**Note**  
Cover cap 792.02.399 is required.

## STORAGE BINS

- Hook to wall track 792.00.000
- With label slots on front



**Material/Color**  
Plastic, black

W x D x H	Item No.
4 1/4" x 5 1/4" x 3"	792.02.380
4 1/4" x 7 1/4" x 3"	792.02.381
5 1/2" x 10 3/4" x 5"	792.02.382

## COVER CAP

- W x D x H: 1 1/16" x 11/16" x 1 1/2"

**Material**  
Plastic



Color	Item No.
black	792.02.399

## LEVELERS WITH 1" ADJUSTMENT

- Easy to cut with saw blade for custom lengths
- Static weight rating: 352 lbs.
- W x D: 3 1/2" x 2"



**Material/Color**  
Tube: Aluminum; Foot: Plastic, black

Height	matt aluminum	Height	black
3 1/2"	792.01.080	3"	792.01.380
6"	792.01.081	6"	792.01.381
9"	792.01.082	9"	792.01.382
12"	792.01.083	-	-

## GARAGE FOOT

- Specifically designed for demanding garage applications
- Coated with a special resin clear coat which is resistant to UV rays, and salt spray tested to 200 hours
- Feet can be cut to length if required

**Material/Color:**  
Nickel-plated, brushed and resin epoxy-coated, matt  
Threaded Insert: Steel, matt; Leveler: Steel; Foot: Nylon, matt white

Height	Item No.
6"	635.48.060
12"	635.48.061

**Supplied with**  
4 Feet, Threaded inserts and levelers, 16 Mounting screws, #8 x 3/4"

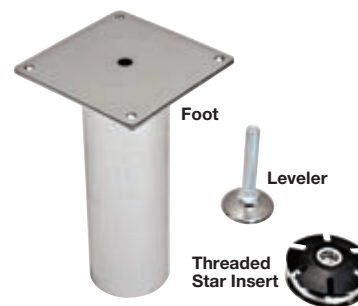

# OMNI TRACK® CLOSET

Hooks are used with wall track 792.00.000.

**Note**

Cover cap 792.02.099 is required.



## TIE HOOK

- Storage for 8 ties
- W x D x H: 4 1/16" x 1 7/8" x 4 3/4"

**Material**  
Steel



Finish	Item No.
matt aluminum	792.03.900

## BRACELET HOOK

- Stores bracelets, necklaces and other jewelry
- W x D x H: 9" x 3 11/16" x 2 1/2"

**Material**  
Steel



Finish	Item No.
matt aluminum	792.03.940

## BELT HOOK

- Storage for 4 belts
- W x D x H: 3 3/8" x 2 13/16" x 5 9/16"

**Material**  
Steel



Finish	Item No.
matt aluminum	792.03.910

## VALET HOOK

- Storage for clothes on hangers
- W x D x H: 1 1/2" x 3 3/4" x 4 15/16"

**Material**  
Steel



Finish	Item No.
matt aluminum	792.03.950

## DOUBLE HOOK

- Stores jewelry, hats, ironing board, etc.
- W x D x H: 3 5/8" x 2 5/8" x 2 1/16"

**Material**  
Steel



Finish	Item No.
matt aluminum	792.03.920

## COAT HOOK

- With rounded top
- W x D x H: 2 3/16" x 2 1/16" x 6 1/4"

**Material**  
Steel



Finish	Item No.
matt aluminum	792.03.930

## COVER CAP

- W x D x H: 1 11/16" x 11/16" x 1 9/16"

**Material**  
Plastic



Color	Item No.
silver	792.02.099

# OMNI TRACK® OFFICE

Hooks are used with wall track 792.00.000.



## PAPER TRAY

- Holds 8 1/2" x 11" paper
- W x D x H: 13 1/4" x 9 5/8" x 7/8"



**Material**  
Steel

Finish	Item No.
silver	818.83.910

## PENCIL TRAY

- Holds pencils and other small items
- W x D x H: 7 3/4" x 3 5/8" x 7/8"



**Material**  
Steel

Finish	Item No.
silver	818.83.920

## SMALL TRAY

- Storage for paper clips and other small items
- W x D x H: 2 3/4" x 3 3/8" x 7/8"



**Material**  
Steel

Finish	Item No.
silver	818.83.930

## UPRIGHT TRAY

- Stores pens, pencils and other small items
- W x D x H: 3 1/4" x 1 9/16" x 3 1/2"



**Material**  
Steel

Finish	Item No.
silver	818.83.940

## FILE HANGER

- Holds 8 1/2" x 11" hanging file folders
- A second file hanger can be added on the front for additional storage
- W x D x H: 12 1/4" x 2 13/16" x 4"



**Material**  
Steel

Finish	Item No.
silver	818.83.900

## J CHANNEL

- Used to create a cork board or white board solution
- L x W x H: 97" x 7/16" x 1 1/2"



**Material**  
Aluminum

Finish	Item No.
matt aluminum	792.01.045

## DECORATIVE HARDWARE



Designers and owners have — and very rightfully so — passionate attachments to decorative hardware. We do too. That's precisely why Häfele's selection of decorative hardware covers such a wide array of styles — from Farmhouse or Industrial to Traditional or Modern — with so many on-trend finishes to match. So whether you need a few knobs and handles, appliance pulls or even ADA-friendly handles, Häfele has you covered.

# TAG ELITE HANDLE COLLECTION

**Note**

Finishes match and are ideal for use with Synergy, Synergy Elite, Engage and Signature closet accessories. Supplied with 1" screws.  
 \* Indicates finish shown.



**Material**  
Zinc

Finish	Item No.
polished chrome	111.95.150
matt aluminum	111.95.151
matt nickel	111.95.152
dark oil-rubbed bronze*	111.95.153
matt gold	111.95.154
slate/graphite	111.95.155

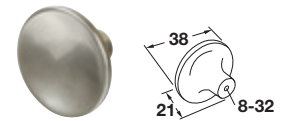

**Material**  
Zinc

Finish	Item No.
polished chrome	111.95.140
matt aluminum	111.95.141
matt nickel*	111.95.142
dark oil-rubbed bronze	111.95.143
matt gold	111.95.144
slate/graphite	111.95.145

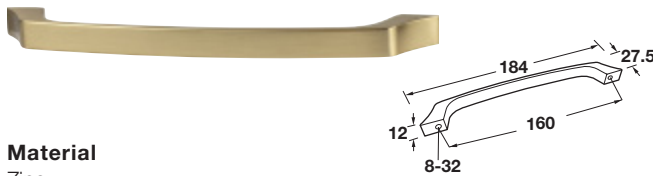

**Material**  
Zinc

Finish	Item No.
polished chrome	111.95.130
matt aluminum	111.95.131
matt nickel	111.95.132
dark oil-rubbed bronze	111.95.133
matt gold*	111.95.134
slate/graphite	111.95.135

Dimensions in mm unless otherwise noted.



# TAG ELITE HANDLE COLLECTION

**Note**

Finishes match and are ideal for use with Synergy, Synergy Elite, Engage and Signature closet accessories. Supplied with 1" screws.  
 \* Indicates finishes shown in order.



**Material**  
Aluminum

Finish	Length 3"	Length 9"	Length 18.5"	Length 24.5"	Length 30.5"	Length 36.5"
polished chrome	111.95.230	111.95.241	111.95.231	111.95.232	111.95.233	111.95.234
matt aluminum*	111.95.190	111.95.242	111.95.195	111.95.200	111.95.205	111.95.210
dark oil-rubbed bronze*	111.95.191	111.95.243	111.95.196	111.95.201	111.95.206	111.95.211
matt gold*	111.95.192	111.95.244	111.95.197	111.95.202	111.95.207	111.95.212
slate/graphite	111.95.220	111.95.240	111.95.221	111.95.222	111.95.223	111.95.224

Dimensions in mm unless otherwise noted.

# TAG ELITE HANDLE COLLECTION

**Note**

Finishes match and are ideal for use with Synergy, Synergy Elite, Engage and Signature closet accessories. Supplied with 1" screws.  
 \* Indicates finish shown.



**Material**

Zinc

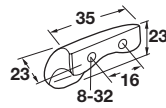

Finish	Item No.
polished chrome	111.95.160
matt aluminum	111.95.161
matt nickel	111.95.162
dark oil-rubbed bronze	111.95.163
matt gold*	111.95.164
slate/graphite	111.95.165

**Material**

Zinc

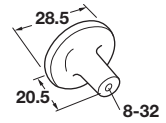

Finish	Item No.
polished chrome	111.95.170
matt aluminum	111.95.171
matt nickel*	111.95.172
dark oil-rubbed bronze	111.95.173
matt gold	111.95.174
slate/graphite	111.95.175

**Material**

Zinc

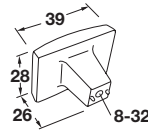

Finish	Item No.
polished chrome	111.95.000
matt aluminum*	111.95.001
matt nickel	111.95.004
dark oil-rubbed bronze	111.95.002
matt gold	111.95.003
slate/graphite	111.95.005

**Material**

Zinc

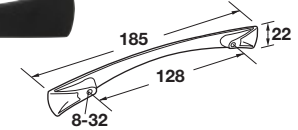

Finish	Item No.
polished chrome	111.95.180
matt aluminum	111.95.181
matt nickel	111.95.182
dark oil-rubbed bronze*	111.95.183
matt gold	111.95.184
slate/graphite	111.95.185

Dimensions in mm unless otherwise noted.

# TAG MODERN HANDLE COLLECTION

**Note**

Finishes match and are ideal for use with Synergy, Synergy Elite, Engage and Signature closet accessories. Supplied with 1" screws.  
 \* Indicates finish shown.

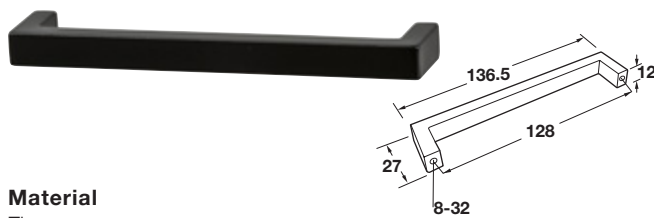

**Material**  
Zinc

Finish	Item No.
polished chrome	111.95.100
matt aluminum	111.95.101
matt nickel	111.95.102
dark oil-rubbed bronze*	111.95.103
matt gold	111.95.104
slate/graphite	111.95.105



**Material**  
Zinc

Finish	Item No.
polished chrome*	111.95.120
matt aluminum	111.95.121
matt nickel	111.95.122
dark oil-rubbed bronze	111.95.123
matt gold	111.95.124
slate/graphite	111.95.125

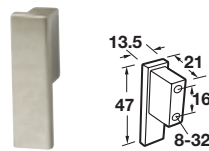

**Material**  
Zinc

Finish	Item No.
polished chrome	111.95.110
matt aluminum	111.95.111
matt nickel*	111.95.112
dark oil-rubbed bronze	111.95.113
matt gold	111.95.114
slate/graphite	111.95.115

Dimensions in mm unless otherwise noted.

# TAG ILLUMINATED GLASS SHELF



- Can be mounted alone or above a drawer to showcase jewelry and other accessories
- Includes 12V Loox LED Lighting in your choice of 3000K (warm white) or 4000K (cool white)
- Mounts quickly and easily with concealed hardware for an attractive installation
- Shelf frame coordinates with other accessories like ENGAGE, while the glass surface increases visibility
- Shelf has been tested to hold up to 55 lbs.
- Optional 1" filler strip available to extend shelf depth

**Material**

Aluminum, Tempered safety glass



**Light color: 3000K warm white**

Depth	Width	matt gold	matt nickel	slate
13 3/4"	18"	807.76.800	807.76.600	807.76.300
	24"	807.76.801	807.76.601	807.76.301
	30"	807.76.802	807.76.602	807.76.302
	36"	807.76.803	807.76.603	807.76.303
20 1/2"	18"	807.76.820	807.76.620	807.76.320
	24"	807.76.821	807.76.621	807.76.321
	30"	807.76.822	807.76.622	807.76.322
	36"	807.76.823	807.76.623	807.76.323



**Light color: 4000K cool white**

Depth	Width	matt gold	matt nickel	slate
13 3/4"	18"	807.76.810	807.76.610	807.76.310
	24"	807.76.811	807.76.611	807.76.311
	30"	807.76.812	807.76.612	807.76.312
	36"	807.76.813	807.76.613	807.76.313
20 1/2"	18"	807.76.830	807.76.630	807.76.330
	24"	807.76.831	807.76.631	807.76.331
	30"	807.76.832	807.76.632	807.76.332
	36"	807.76.833	807.76.633	807.76.333

**Supplied With**

12V Loox LED Lighting

**Note**

Drivers, dimmers and switches need to be purchased separately. See pages 151-152

**FILLER STRIP**

- Allows shelf depth to be extended by 1"

**Material**

Aluminum



Width	matt gold	matt nickel	slate
18"	807.76.890	807.76.690	807.76.390
24"	807.76.891	807.76.691	807.76.391
30"	807.76.892	807.76.692	807.76.392
36"	807.76.893	807.76.693	807.76.393

# ELITE WARDROBE TUBES

**Note**

\*Indicates finish shown.

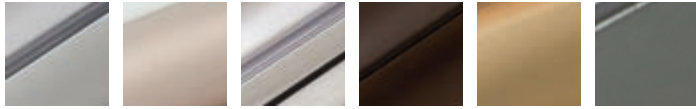

matt aluminum    matt nickel    polished chrome    oil-rubbed bronze    matt gold    slate



## WARDROBE TUBES

- 1 5/16" x 8'

**Material**

Aluminum, anodized; Insert: Plastic



Finish	Insert	Item No.
matt aluminum	clear	830.28.700
matt nickel	clear	830.28.710
polished chrome*	clear	830.28.720
oil-rubbed bronze	black	830.28.730
matt gold	clear	830.28.790
slate	black	830.28.800

- 1 5/16" x 4'

Finish	Insert	Item No.
matt aluminum	clear	830.28.701
matt nickel	clear	830.28.711
polished chrome*	clear	830.28.721
oil-rubbed bronze	black	830.28.731
matt gold	clear	830.28.705
slate	black	830.28.706

**Supplied With**

Flat milk lens

## WARDROBE TUBE SUPPORT

- Ø: 1 1/4"
- Unique two-part design allows the support to fully surround the tube ends
- Connect the wedge shaped brackets into line bore holes and side supports onto the end of the tube
- Side supports connect to the wedge shaped brackets
- With two pins for 5 mm holes
- 32 mm (1 1/4") spacing with an additional screw hole for side panel mounting

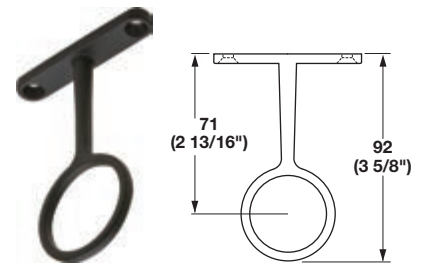

## WARDROBE TUBE CENTER SUPPORT

- Surface mount
- For 1 5/16" tube

**Material**

Zinc die-cast

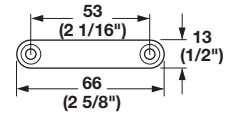

Finish	Item No.
matt aluminum	802.06.367
matt nickel	802.06.667
polished chrome	802.06.267
dark oil-rubbed bronze*	802.06.167
matt gold	802.06.067
slate	802.06.467

**Supplied With**

Screws

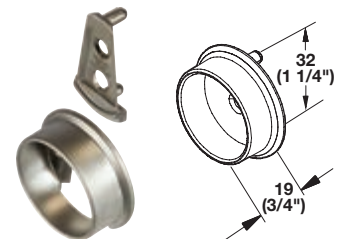

**Material**

Zinc-plated

Finish	Item No.
matt aluminum	803.39.410
matt nickel*	803.39.610
polished chrome	803.39.210
oil-rubbed bronze	803.39.110
matt gold	803.39.910
slate	803.39.710

# ELITE LIGHTED WARDROBE TUBE KIT

**Note**

\*Indicates finish shown.



**LOOX 2037**

- CRI: 90
- CRI 90 lights offer more vibrant, true color rendering than lower CRI products and are Title 24 Compliant
- Choose from warm or cool white
- Ready to install
- Tube is cut 1/4" shorter than nominal size to allow room for end caps and driver cable exit

**Note**

Position cable around and out of tube between lens and end cap or through end cap exit hole.

**Material**

Aluminum

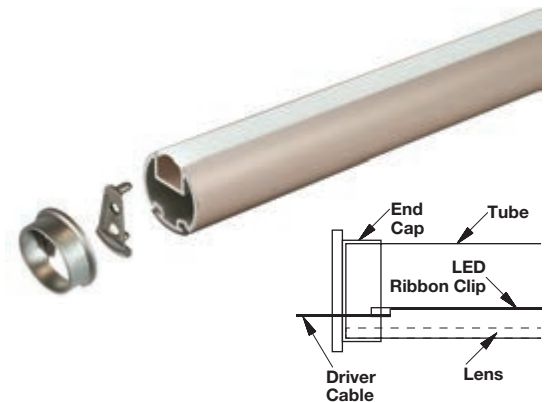

**Light color: 3000K warm white**

Length	Wattage	Lumen	matt aluminum	polished chrome	matt nickel*	oil-rubbed bronze	matt gold	slate
18"	1.8	146	833.71.032	833.71.064	830.28.780	833.71.048	833.71.916	830.38.810
24"	2.4	195	833.71.033	833.71.065	830.28.781	833.71.049	833.71.917	830.28.811
30"	3.1	243	833.71.034	833.71.066	830.28.782	833.71.050	833.71.918	830.28.812
36"	3.7	292	833.71.035	833.71.067	830.28.783	833.71.051	833.71.919	830.28.813

**Light color: 4000K cool white**

Length	Wattage	Lumen	matt aluminum	polished chrome	matt nickel	oil-rubbed bronze	matt gold	slate
18"	1.8	146	833.71.024	833.71.056	830.28.786	833.71.041	833.71.913	830.28.814
24"	2.4	195	833.71.025	833.71.057	830.28.786	833.71.041	833.71.913	830.28.815
30"	3.1	243	833.71.025	833.71.058	830.28.787	833.71.042	833.71.914	830.28.816
36"	3.7	292	833.71.027	833.71.059	830.28.788	833.71.043	833.71.915	830.28.817

**Supplied With**

Tube, lens, Loox 2037 flexible light strip, 78 3/4" driver cable, 2 end caps

**Note**

Loox lights and drivers are "suitable for use within closet storage spaces"

# LOOX LED DRIVER

## 12 V SYSTEM

- Suitable for all of the world's power systems
- With an integrated port for a wide selection of switches
- Max. 42 W per light output
- Max. lead length from driver to switch: 236 1/4"
- Drivers must be mounted in well ventilated area



### Material/Finish

Plastic, black

L x W x H	Wattage	Standby power consumption wattage	Input voltage	Output voltage	Output current	Number of slots	Item No.
8 3/16" x 2 1/4" x 1 3/16"	0 – 60	<0.2	100 – 240 V~; 50 – 60 Hz	12 V DC	5.0 A	6 for lights, 1 for switch, 1 for power cord	833.74.913

**Supplied With** Mounting accessories, US power cord

**Note** Loox lights and drivers are "suitable for use within closet storage spaces"

## DIMMER SWITCHES

- Soft on/off switching
- Available in touch or touch-free

### Material/Finish

Plastic, silver colored

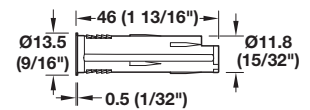

Switching	Drill hole Ø	Power consumption	Power rating	Degree of protection	Sensor range	Item No.
touch	1/2"	≤0.3 W	90 W	IP20	-	833.89.058
touch-free	1/2"	≤0.3 W	90 W	IP20	0" – 2 3/8"	833.89.126

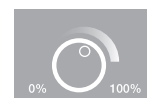

**Note** Dimming value is stored without the need for power supply (memory function)  
Order lead for modular switch to Loox driver separately

# LOOX LED DRIVER MODULAR SWITCHES

## SENSOR SWITCH, TOUCHLESS

- Soft on/off switching
- For mounting under cabinet or shelf

### Material/Finish

Plastic, silver colored

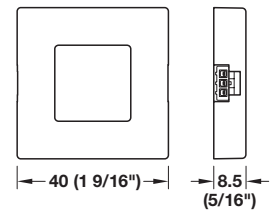
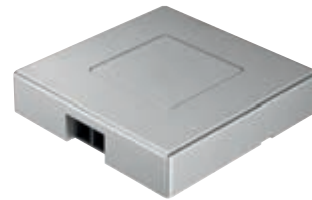

L x W x H	Power Consumption	Power rating	Degree of protection	Sensor range	Item No.
1 9/16" x 1 9/16" x 5/16"	≤0.3 W	90 W	IP20	0 – 80 (0" – 2 1/8")	833.89.136



**Supplied With** Mounting material

**Note** On/off state is stored without the need for power supply (memory function)  
Order lead for modular switch to Loox driver separately

## DIMMER SWITCH, TOUCH

- Soft on/off switching
- For mounting under cabinet or shelf

### Material/Finish

Plastic, silver colored

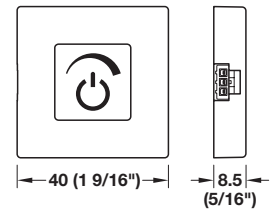

L x W x H	Power Consumption	Power rating	Degree of protection	Sensor range	Item No.
1 9/16" x 1 9/16" x 5/16"	≤0.3 W	90 W	-	0" – 2 1/8"	833.89.134

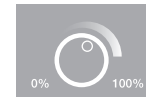

**Supplied With** Mounting material

**Note** On/off state is stored without the need for power supply (memory function)  
Order lead for modular switch to Loox driver separately

## LEAD FOR MODULAR SWITCHES

- Degree of protection: IP20

### Material/Finish

Plastic, black



Length	Item No.
19 11/16"	833.89.140
39 3/8"	833.89.141
78 3/4"	833.89.142



## INDEX

Item No.	Page No.	Item No.	Page No.	Item No.	Page No.	Item No.	Page No.
020.92.761	112	111.95.142	127	111.95.240	128	124.02.432	124
100.45.051	126	111.95.143	127	111.95.241	128	124.02.501	124
100.45.055	126	111.95.144	127	111.95.242	128	124.02.920	124
102.47.953	123	111.95.150	127	111.95.243	128	124.02.921	124
103.79.400	117	111.95.151	127	111.95.244	128	125.68.051	114
103.79.411	117	111.95.152	127	117.05.600	121	125.68.052	114
104.08.000	123	111.95.153	127	117.05.610	121	125.68.351	114
104.35.600	125	111.95.154	127	117.05.620	121	125.68.352	114
107.18.352	115	111.95.160	129	117.05.640	121	131.33.700	121
107.18.353	115	111.95.161	129	117.31.108	118	133.50.111	141
107.18.358	115	111.95.162	129	117.31.118	118	133.50.112	141
107.18.612	115	111.95.163	129	117.31.228	118	133.50.113	141
107.18.613	115	111.95.164	129	117.31.238	118	133.50.117	141
107.18.618	115	111.95.170	129	117.31.308	118	133.50.118	141
109.50.274	125	111.95.171	129	117.31.318	118	133.50.119	141
110.18.037	114	111.95.172	129	117.31.368	118	133.50.123	141
110.18.057	114	111.95.173	129	117.31.398	118	133.50.124	141
111.25.252	117	111.95.174	129	117.31.408	118	133.50.125	141
111.25.262	117	111.95.180	129	117.31.418	118	133.50.134	134
111.95.000	129	111.95.181	129	117.31.628	118	133.50.147	134
111.95.001	129	111.95.182	129	117.31.638	118	133.50.150	134
111.95.002	129	111.95.183	129	117.97.160	120	133.50.152	134
111.95.003	129	111.95.184	129	117.97.161	120	133.50.187	137
111.95.004	129	111.95.190	128	117.97.162	119	133.50.190	137
111.95.063	126	111.95.191	128	117.97.163	119	133.50.195	137
111.95.069	126	111.95.192	128	117.97.164	119	133.50.198	137
111.95.100	130	111.95.195	128	117.97.165	120	133.50.239	137
111.95.101	130	111.95.196	128	117.97.260	120	133.50.240	137
111.95.102	130	111.95.197	128	117.97.261	120	133.50.243	137
111.95.103	130	111.95.200	128	117.97.262	119	133.50.244	137
111.95.104	130	111.95.201	128	117.97.263	119	133.50.253	135
111.95.110	130	111.95.202	128	117.97.264	119	133.50.255	135
111.95.111	130	111.95.205	128	117.97.265	120	133.50.256	135
111.95.112	130	111.95.206	128	117.97.460	120	133.50.258	135
111.95.113	130	111.95.207	128	117.97.461	120	133.50.259	135
111.95.114	130	111.95.210	128	117.97.462	119	133.50.261	135
111.95.120	130	111.95.211	128	117.97.463	119	133.50.303	135
111.95.121	130	111.95.212	128	117.97.464	119	133.50.304	135
111.95.122	130	111.95.220	128	117.97.465	120	133.50.305	135
111.95.123	130	111.95.221	128	117.97.660	120	133.50.306	135
111.95.124	130	111.95.222	128	117.97.661	120	133.50.307	135
111.95.130	127	111.95.223	128	117.97.662	119	133.50.308	135
111.95.131	127	111.95.224	128	117.97.663	119	133.50.323	133
111.95.132	127	111.95.230	128	117.97.664	119	133.50.324	133
111.95.133	127	111.95.231	128	117.97.665	120	133.50.325	133
111.95.134	127	111.95.232	128	124.02.220	124	133.50.326	133
111.95.140	127	111.95.233	128	124.02.320	124	133.50.329	133
111.95.141	127	111.95.234	128	124.02.332	124	133.50.330	133

# INDEX

Item No.	Page No.	Item No.	Page No.	Item No.	Page No.	Item No.	Page No.
133.50.357	132	134.06.101	123	237.56.352	53	502.72.993	85
133.50.359	132	134.06.241	123	237.56.380	54	503.15.365	88
133.50.360	132	134.06.301	123	237.56.381	54	503.15.765	88
133.50.361	132	134.06.311	123	237.56.974	54	503.15.865	88
133.50.363	132	134.06.441	123	237.56.988	54	505.03.232	96
133.50.364	132	134.06.442	123	237.56.992	54	520.06.700	86
133.50.365	132	134.06.631	123	237.56.994	54	520.06.701	86
133.50.368	132	134.06.641	123	237.56.995	54	520.06.710	86
133.50.369	132	135.73.400	117	237.56.996	54	520.06.730	87
133.50.373	136	135.73.410	117	237.56.997	54	520.06.740	87
133.50.375	136	138.72.800	117	237.56.998	54	520.06.750	87
133.50.376	136	139.60.422	117	237.56.999	54	520.06.760	86
133.50.378	136	155.00.040	116	271.92.016	52	520.06.770	87
133.50.379	136	155.00.041	116	271.92.025	52	520.06.790	86
133.50.381	136	155.00.060	116	271.92.132	52	520.06.820	87
133.50.382	131	155.00.061	116	271.98.100	52	520.10.009	94
133.50.384	131	155.00.071	116	283.33.941	112	520.20.280	50
133.50.385	131	155.00.072	116	283.38.020	112	520.44.500	94
133.50.387	131	155.00.091	116	422.74.310	99	520.44.700	94
133.50.391	131	155.00.092	116	422.74.320	99	521.99.300	93
133.50.393	131	155.00.440	122	429.59.340	98	521.99.310	93
133.50.633	136	155.00.441	122	429.59.350	98	521.99.320	93
133.50.634	136	155.00.491	122	429.97.222	104	521.99.331	93
133.50.635	136	155.00.492	122	429.97.231	104	521.99.332	93
133.50.636	136	155.00.600	122	429.97.240	104	521.99.333	93
133.50.637	136	155.00.601	122	429.97.526	104	521.99.900	93
133.50.638	136	155.00.750	119	429.99.020	104	521.99.910	93
133.50.639	131	155.00.760	119	429.99.039	104	521.99.920	93
133.50.640	131	155.00.761	119	429.99.048	104	521.99.931	93
133.50.642	131	155.00.762	119	429.99.128	104	521.99.932	93
133.50.657	138	155.00.763	119	429.99.137	104	521.99.933	93
133.50.664	138	155.00.780	121	429.99.146	104	540.06.996	47
133.50.678	138	155.00.781	121	429.99.324	104	540.09.755	47
133.50.679	138	155.00.783	121	429.99.333	104	540.36.207	95
133.50.682	139	155.00.787	121	429.99.342	104	540.42.200	95
133.50.686	139	155.00.789	121	429.99.422	104	540.50.104	92
133.50.687	139	155.00.795	121	429.99.431	104	540.50.107	92
133.50.691	139	155.00.810	121	429.99.440	104	540.50.114	92
133.50.692	139	155.00.811	121	429.99.520	104	540.50.117	92
133.50.696	139	155.01.610	116	429.99.539	104	540.50.204	92
133.50.697	139	155.01.611	116	429.99.548	104	540.50.207	92
133.50.702	139	155.01.612	116	429.99.726	104	540.50.214	92
133.50.707	140	155.01.613	116	429.99.735	104	540.50.217	92
133.50.708	140	155.01.620	116	429.99.744	104	543.19.260	95
133.50.709	140	155.01.621	116	502.72.701	85	543.19.280	95
133.50.710	140	155.01.622	116	502.72.702	85	547.35.484	44
133.79.051	114	155.01.623	116	502.72.705	85	547.35.485	44
133.79.351	114	237.56.350	53	502.72.990	85	547.35.486	44

## INDEX

<b>Item No.</b>	<b>Page No.</b>	<b>Item No.</b>	<b>Page No.</b>	<b>Item No.</b>	<b>Page No.</b>	<b>Item No.</b>	<b>Page No.</b>
547.35.487	44	547.40.136	43	547.41.536	43	547.43.399	37
547.35.488	44	547.40.138	43	547.41.538	43	547.51.101	47
547.35.489	44	547.40.152	43	547.41.632	43	547.51.102	47
547.36.484	44	547.40.156	43	547.41.636	43	547.51.103	47
547.36.485	44	547.40.158	43	547.41.638	43	547.51.104	47
547.36.486	44	547.40.212	43	547.41.652	43	547.51.106	47
547.36.487	44	547.40.216	43	547.41.656	43	547.51.201	47
547.36.488	44	547.40.218	43	547.41.658	43	547.51.202	47
547.36.489	44	547.40.232	43	547.41.732	43	547.51.203	47
547.37.484	44	547.40.236	43	547.41.736	43	547.51.204	47
547.37.485	44	547.40.238	43	547.41.738	43	547.51.206	47
547.37.486	44	547.40.252	43	547.41.752	43	547.51.218	95
547.37.487	44	547.40.256	43	547.41.756	43	547.51.227	95
547.37.488	44	547.40.258	43	547.41.758	43	547.51.236	95
547.37.489	44	547.40.532	43	547.42.131	45	547.51.245	95
547.38.132	43	547.40.536	43	547.42.132	45	547.51.254	95
547.38.136	43	547.40.538	43	547.42.141	45	547.51.263	95
547.38.138	43	547.40.632	43	547.42.142	45	547.51.601	47
547.38.152	43	547.40.636	43	547.42.190	45	547.51.602	47
547.38.156	43	547.40.638	43	547.42.231	45	547.51.603	47
547.38.158	43	547.40.652	43	547.42.232	45	547.51.604	47
547.38.212	43	547.40.656	43	547.42.241	45	547.51.606	47
547.38.216	43	547.40.658	43	547.42.242	45	547.52.040	28
547.38.218	43	547.40.712	43	547.42.485	46	547.52.121	28
547.38.232	43	547.40.716	43	547.42.486	46	547.52.122	28
547.38.236	43	547.40.718	43	547.42.487	46	547.52.123	28
547.38.238	43	547.40.732	43	547.42.488	46	547.52.124	28
547.38.252	43	547.40.736	43	547.42.531	45	547.52.126	28
547.38.256	43	547.40.738	43	547.42.532	45	547.52.140	28
547.38.258	43	547.40.752	43	547.42.590	45	547.52.180	28
547.38.532	43	547.40.756	43	547.42.631	45	547.52.190	28
547.38.536	43	547.40.758	43	547.42.632	45	547.52.199	28
547.38.538	43	547.41.132	43	547.42.641	45	547.52.221	28
547.38.632	43	547.41.136	43	547.42.642	45	547.52.222	28
547.38.636	43	547.41.138	43	547.42.690	45	547.52.223	28
547.38.638	43	547.41.152	43	547.42.731	45	547.52.224	28
547.38.652	43	547.41.156	43	547.42.732	45	547.52.226	28
547.38.656	43	547.41.158	43	547.42.741	45	547.52.240	28
547.38.658	43	547.41.212	43	547.42.742	45	547.52.280	28
547.38.716	43	547.41.216	43	547.42.990	45	547.52.290	28
547.38.718	43	547.41.218	43	547.42.991	45	547.52.299	28
547.38.732	43	547.41.232	43	547.42.993	46	547.52.321	28
547.38.736	43	547.41.236	43	547.42.994	46	547.52.322	28
547.38.738	43	547.41.238	43	547.43.301	37	547.52.323	28
547.38.752	43	547.41.252	43	547.43.303	37	547.52.324	28
547.38.756	43	547.41.256	43	547.43.305	37	547.52.326	28
547.38.758	43	547.41.258	43	547.43.390	37	547.52.340	28
547.40.132	43	547.41.532	43	547.43.391	37	547.52.380	28

# INDEX

Item No.	Page No.	Item No.	Page No.	Item No.	Page No.	Item No.	Page No.
547.52.390	28	563.55.931	146	635.61.397	106	792.01.082	67
547.52.399	28	563.56.031	146	635.61.476	106	792.01.083	67
547.52.421	28	563.56.061	146	635.61.496	106	792.01.380	67
547.52.422	28	563.56.131	146	635.61.977	106	792.01.381	67
547.52.423	28	563.56.161	146	635.61.996	106	792.01.382	67
547.52.424	28	563.56.331	146	771.80.430	51	792.01.993	61
547.52.426	28	563.56.361	146	771.80.431	51	792.01.998	61
547.52.621	28	563.56.731	146	771.80.435	51	792.02.000	62
547.52.622	28	563.56.761	146	771.80.436	51	792.02.004	62, 65
547.52.623	28	563.56.931	146	774.21.221	111	792.02.005	62, 64
547.52.624	28	563.56.961	146	774.21.223	111	792.02.006	65
547.52.626	28	568.60.581	50	774.21.225	111	792.02.007	67
547.52.640	28	568.60.710	50	774.21.226	111	792.02.060	65
547.52.680	28	568.60.781	50	774.21.228	111	792.02.070	64
547.52.690	28	568.66.700	50	774.21.230	111	792.02.099	68
547.52.699	28	568.66.790	50	774.21.231	111	792.02.200	62, 64
547.52.921	28	630.44.980	108	774.21.700	110	792.02.201	62, 65
547.52.922	28	630.44.981	108	774.21.702	110	792.02.202	62, 64
547.52.923	28	630.46.212	107	774.21.704	110	792.02.203	62, 64
547.52.924	28	630.46.240	107	774.21.705	110	792.02.240	62
547.52.926	28	630.46.312	107	774.21.707	110	792.02.241	62
547.52.940	28	630.46.340	107	774.21.709	110	792.02.250	62, 66
547.52.980	28	630.46.360	108	774.21.711	110	792.02.251	62, 66
547.52.990	28	630.46.361	108	774.24.222	111	792.02.252	62, 66
547.52.999	28	631.20.310	104	774.24.223	111	792.02.253	62, 66
547.94.385	49	631.20.710	104	774.24.224	111	792.02.254	62, 66
547.94.485	49	631.20.910	104	774.24.225	111	792.02.255	62, 66
547.95.431	46	631.26.111	104	774.24.226	111	792.02.349	62, 64, 65
547.95.432	46	631.26.112	104	774.24.227	111	792.02.380	62, 67
547.95.433	46	631.26.311	104	774.24.228	111	792.02.381	62, 67
547.95.434	46	631.26.411	104	774.24.229	111	792.02.382	62, 67
547.98.441	44	631.26.412	104	774.24.230	111	792.02.399	62, 67
547.98.443	44	631.26.511	104	774.25.703	110	792.03.900	68
547.98.445	44	631.26.512	104	774.25.704	110	792.03.910	68
547.98.452	44	631.26.611	104	774.25.705	110	792.03.920	68
547.98.454	44	631.26.711	104	774.25.706	110	792.03.930	68
547.98.456	44	631.35.014	104	774.25.707	110	792.03.940	68
547.98.461	44	631.35.214	104	792.00.000	61, 63	792.03.950	68
547.98.463	44	631.35.314	104	792.00.001	61	792.10.121	73
547.98.465	44	632.52.300	98	792.00.002	61	792.10.142	74
547.98.472	44	633.44.000	99	792.00.310	61	792.10.162	74
547.98.474	44	635.48.060	67	792.00.320	61, 63	792.10.182	75
547.98.476	44	635.48.061	67	792.01.000	63	792.10.321	73
563.55.031	146	635.61.276	106	792.01.030	63	792.10.342	74
563.55.131	146	635.61.295	106	792.01.045	69	792.10.362	74
563.55.331	146	635.61.376	106	792.01.060	124	792.10.382	75
563.55.531	146	635.61.378	106	792.01.080	67	792.10.521	73
563.55.731	146	635.61.395	106	792.01.081	67	792.10.542	74

## INDEX

<b>Item No.</b>	<b>Page No.</b>	<b>Item No.</b>	<b>Page No.</b>	<b>Item No.</b>	<b>Page No.</b>	<b>Item No.</b>	<b>Page No.</b>
792.10.562	74	792.13.080	80	793.00.126	58	793.00.443	57
792.10.582	75	792.13.090	72, 80	793.00.127	58	793.00.444	58
792.10.621	73	792.14.000	81	793.00.128	58	793.00.445	57
792.10.642	74	792.14.010	72, 81	793.00.129	56	793.00.446	57
792.10.662	74	792.14.020	80	793.00.130	56	793.00.447	58
792.10.682	75	792.14.030	72, 81	793.00.400	57	793.00.448	58
792.10.721	73	792.14.050	71, 82	793.00.401	57	793.00.449	58
792.10.742	74	792.14.051	71, 82	793.00.402	58	793.00.450	58
792.10.762	74	792.14.060	71, 83	793.00.403	57	793.00.451	58
792.10.782	75	792.14.070	71, 83	793.00.404	57	801.09.239	38
792.10.821	73	792.14.071	83	793.00.405	58	801.13.184	38
792.10.842	74	792.14.080	71, 83	793.00.406	57	801.13.185	38
792.10.862	74	792.14.090	83	793.00.407	57	801.13.186	38
792.10.882	75	792.14.540	82	793.00.408	58	801.13.187	38
792.10.931	73	792.14.640	82	793.00.409	57	801.13.188	38
792.10.952	74	792.15.300	71, 83	793.00.410	57	801.13.191	38
792.10.972	74	792.16.100	73	793.00.411	58	801.13.201	38
792.10.992	75	792.16.101	73	793.00.412	57	801.13.244	38
792.11.102	75	792.16.130	73	793.00.413	57	801.13.245	38
792.11.302	75	792.16.160	73	793.00.414	58	801.13.246	38
792.11.502	75	792.16.300	73	793.00.415	57	801.13.247	38
792.11.602	75	792.16.301	73	793.00.416	57	801.13.248	38
792.11.702	75	792.16.400	73	793.00.417	58	801.13.384	38
792.11.802	75	792.16.401	73	793.00.418	57	801.13.385	38
792.11.912	75	792.16.460	73	793.00.419	57	801.13.386	38
792.12.000	76	792.16.500	73	793.00.420	58	801.13.387	38
792.12.010	71, 72, 76	792.16.501	73	793.00.421	57	801.13.388	38
792.12.020	71, 72, 76	792.16.530	73	793.00.422	57	801.13.391	38
792.12.030	71, 72, 76	792.16.560	73	793.00.423	58	801.13.684	38
792.12.040	72, 76	792.16.600	73	793.00.424	57	801.13.685	38
792.12.050	71, 72, 77	792.16.601	73	793.00.425	57	801.13.686	38
792.12.051	71, 72, 77	792.16.630	73	793.00.426	58	801.13.687	38
792.12.060	71, 72, 77	792.16.660	73	793.00.427	57	801.13.688	38
792.12.061	71, 72, 78	792.16.700	73	793.00.428	57	801.13.691	38
792.12.070	71, 72, 77	792.16.701	73	793.00.429	58	801.42.040	24
792.12.071	71, 72, 77	792.16.730	73	793.00.430	57	801.42.055	23
792.12.072	71, 72, 77	792.16.760	73	793.00.431	57	801.42.056	23
792.12.073	71, 72, 77	792.16.900	73	793.00.432	58	801.42.057	23
792.12.080	71, 72, 78	792.16.901	73	793.00.433	57	801.42.058	23
792.12.090	71, 72, 78	792.16.960	73	793.00.434	57	801.42.059	23
792.13.000	72, 78	793.00.001	55	793.00.435	58	801.42.100	32
792.13.010	78	793.00.002	55	793.00.436	57	801.42.134	32
792.13.020	78	793.00.003	56	793.00.437	57	801.42.135	32
792.13.030	71, 72, 79	793.00.004	56	793.00.438	58	801.42.136	32
792.13.040	72, 79	793.00.005	56	793.00.439	57	801.42.137	32
792.13.050	71, 72, 79	793.00.113	55	793.00.440	57	801.42.138	32
792.13.060	72, 80	793.00.114	55	793.00.441	58	801.42.140	24
792.13.070	81	793.00.125	58	793.00.442	57	801.42.155	23

# INDEX

Item No.	Page No.	Item No.	Page No.	Item No.	Page No.	Item No.	Page No.
801.42.156	23	801.78.191	21	802.13.000	22	805.31.301	41
801.42.157	23	801.78.192	21	802.13.100	22	805.31.302	41
801.42.158	23	801.78.193	21	802.13.200	22	805.31.303	41
801.42.159	23	801.78.194	21	802.13.300	22	805.31.323	41
801.42.200	32	801.78.195	21	802.13.600	22	805.32.254	42
801.42.234	32	801.78.212	22	802.13.900	22	805.32.261	42
801.42.235	32	801.78.291	21	803.39.110	24	805.32.262	42
801.42.236	32	801.78.292	21	803.39.110	149	805.32.354	42
801.42.237	32	801.78.293	21	803.39.150	22	805.32.362	42
801.42.238	32	801.78.294	21	803.39.210	24	805.32.461	42
801.42.240	24	801.78.295	21	803.39.210	149	805.32.761	42
801.42.255	23	801.78.312	22	803.39.250	22	805.32.763	42
801.42.256	23	801.78.391	21	803.39.410	24	805.32.764	42
801.42.257	23	801.78.392	21	803.39.410	149	805.40.209	89
801.42.258	23	801.78.393	21	803.39.450	22	805.40.254	89
801.42.259	23	801.78.394	21	803.39.610	24	805.43.250	90
801.42.340	24	801.78.395	21	803.39.610	149	805.58.131	35
801.42.355	23	801.78.412	22	803.39.710	24	805.58.133	35
801.42.356	23	801.78.491	21	803.39.710	149	805.58.135	35
801.42.357	23	801.78.492	21	803.39.750	22	805.58.231	35
801.42.358	23	801.78.493	21	803.39.910	24	805.58.233	35
801.42.359	23	801.78.494	21	803.39.910	149	805.58.235	35
801.42.440	24	801.78.495	21	803.39.950	22	805.58.331	18, 35
801.42.465	23	801.78.612	22	803.56.100	32	805.58.332	18, 35
801.42.466	23	801.78.691	21	803.56.200	32	805.58.631	35
801.42.467	23	801.78.692	21	803.56.600	32	805.58.633	35
801.42.468	23	801.78.693	21	803.56.710	32	805.58.635	35
801.42.469	23	801.78.694	21	803.56.900	32	805.58.931	35
801.42.600	32	801.78.695	21	803.64.000	22	805.58.933	35
801.42.634	32	801.78.912	22	803.64.100	22	805.58.935	35
801.42.635	32	801.78.991	21	803.64.200	22	805.72.030	29
801.42.636	32	801.78.992	21	803.64.300	22	805.72.130	29
801.42.637	32	801.78.993	21	803.64.600	22	805.72.330	29
801.42.638	32	801.78.994	21	803.64.650	22	805.72.630	29
801.42.640	24	801.78.995	21	803.64.900	22	805.72.930	29
801.42.655	23	802.04.208	38	805.01.752	90	805.73.011	29
801.42.656	23	802.06.067	24	805.01.761	90	805.73.021	29
801.42.657	23	802.06.067	149	805.12.303	90	805.73.022	29
801.42.658	23	802.06.167	24, 32	805.12.358	90	805.73.111	29
801.42.659	23	802.06.167	149	805.12.401	90	805.73.121	29
801.42.710	32	802.06.267	24, 32	805.12.456	90	805.73.122	29
801.42.900	32	802.06.267	149	805.31.201	41	805.73.311	29
801.42.934	32	802.06.367	24, 32	805.31.202	41	805.73.321	29
801.42.935	32	802.06.367	149	805.31.203	41	805.73.322	29
801.42.936	32	802.06.467	24	805.31.223	41	805.73.611	29
801.42.937	32	802.06.467	149	805.31.295	41	805.73.621	29
801.42.938	32	802.06.667	24, 32	805.31.296	41	805.73.622	29
801.78.112	22	802.06.667	149	805.31.297	41	805.73.911	29

## INDEX

Item No.	Page No.	Item No.	Page No.	Item No.	Page No.	Item No.	Page No.
805.73.921	29	807.67.113	25	807.67.625	26	807.69.660	30
805.73.922	29	807.67.115	25	807.67.683	26	807.69.901	30
805.87.210	35	807.67.121	26	807.67.685	26	807.69.920	31
805.87.910	35	807.67.123	26	807.67.901	25	807.69.930	31
805.87.993	35	807.67.125	26	807.67.904	25	807.69.931	31
807.32.251	42	807.67.183	26	807.67.905	25	807.69.940	31
807.32.351	42	807.67.185	26	807.67.911	25	807.69.950	31
807.32.661	42	807.67.201	25	807.67.913	25	807.69.960	30
807.52.131	36	807.67.203	25	807.67.915	25	807.72.000	10
807.52.133	36	807.67.205	25	807.67.921	26	807.72.001	10
807.52.135	36	807.67.211	25	807.67.923	26	807.72.002	10
807.52.231	36	807.67.213	25	807.67.925	26	807.72.020	11
807.52.233	36	807.67.215	25	807.67.983	26	807.72.030	11
807.52.235	36	807.67.221	26	807.67.985	26	807.72.040	11
807.52.631	36	807.67.223	26	807.69.000	30	807.72.041	11
807.52.633	36	807.67.225	26	807.69.020	31	807.72.300	10
807.52.635	36	807.67.283	26	807.69.030	31	807.72.301	10
807.52.931	36	807.67.285	26	807.69.031	31	807.72.302	10
807.52.933	36	807.67.301	25	807.69.040	31	807.72.320	11
807.52.935	36	807.67.303	25	807.69.050	31	807.72.330	11
807.54.130	33	807.67.305	25	807.69.060	30	807.72.340	11
807.54.131	33	807.67.311	25	807.69.100	30	807.72.341	11
807.54.132	33	807.67.313	25	807.69.120	31	807.72.410	10
807.54.133	33	807.67.315	25	807.69.130	31	807.72.411	10
807.54.134	34	807.67.321	26	807.69.131	31	807.72.412	10
807.54.230	33	807.67.323	26	807.69.140	31	807.72.413	10
807.54.231	33	807.67.325	26	807.69.150	31	807.72.510	10
807.54.232	33	807.67.383	26	807.69.160	30	807.72.511	10
807.54.233	33	807.67.385	26	807.69.200	30	807.72.512	10
807.54.234	34	807.67.401	25	807.69.220	31	807.72.513	10
807.54.630	33	807.67.403	25	807.69.230	31	807.72.600	10
807.54.631	33	807.67.405	25	807.69.231	31	807.72.601	10
807.54.632	33	807.67.411	25	807.69.240	31	807.72.602	10
807.54.633	33	807.67.413	25	807.69.250	31	807.72.620	11
807.54.634	34	807.67.415	25	807.69.260	30	807.72.630	11
807.54.770	33	807.67.421	26	807.69.320	31	807.72.640	11
807.54.771	33	807.67.423	26	807.69.330	31	807.72.641	11
807.54.772	33	807.67.425	26	807.69.331	31	807.72.710	10
807.54.773	33	807.67.483	26	807.69.340	31	807.72.711	10
807.54.930	33	807.67.485	26	807.69.350	31	807.72.712	10
807.54.931	33	807.67.601	25	807.69.360	30	807.72.713	10
807.54.932	33	807.67.603	25	807.69.370	30	807.72.800	10
807.54.933	33	807.67.605	25	807.69.600	30	807.72.801	10
807.54.934	34	807.67.611	25	807.69.620	31	807.72.802	10
807.67.101	25	807.67.613	25	807.69.630	31	807.72.820	11
807.67.103	25	807.67.615	25	807.69.631	31	807.72.830	11
807.67.105	25	807.67.621	26	807.69.640	31	807.72.840	11
807.67.111	25	807.67.623	26	807.69.650	31	807.72.841	11

# INDEX

<b>Item No.</b>	<b>Page No.</b>	<b>Item No.</b>	<b>Page No.</b>	<b>Item No.</b>	<b>Page No.</b>	<b>Item No.</b>	<b>Page No.</b>
807.76.300	148	807.76.820	148	807.77.424	16	807.77.981	14
807.76.301	148	807.76.821	148	807.77.440	18	807.77.982	14
807.76.302	148	807.76.822	148	807.77.441	18	807.77.983	14
807.76.303	148	807.76.823	148	807.77.442	18	807.77.984	14
807.76.310	148	807.76.830	148	807.77.460	19	807.78.101	13
807.76.311	148	807.76.831	148	807.77.461	19	807.78.102	13
807.76.312	148	807.76.832	148	807.77.462	19	807.78.103	13
807.76.313	148	807.76.833	148	807.77.491	15	807.78.104	13
807.76.320	148	807.76.890	148	807.77.492	16	807.78.111	15
807.76.321	148	807.76.891	148	807.77.499	14	807.78.112	15
807.76.322	148	807.76.892	148	807.77.596	13	807.78.113	15
807.76.323	148	807.76.893	148	807.77.601	13	807.78.114	15
807.76.330	148	807.77.171	20	807.77.602	13	807.78.121	16
807.76.331	148	807.77.172	20	807.77.603	13	807.78.122	16
807.76.332	148	807.77.173	20	807.77.604	13	807.78.123	16
807.76.333	148	807.77.174	20	807.77.611	15	807.78.124	16
807.76.390	148	807.77.181	14	807.77.612	15	807.81.100	18
807.76.391	148	807.77.182	14	807.77.613	15	807.81.101	18
807.76.392	148	807.77.183	14	807.77.614	15	807.81.102	18
807.76.393	148	807.77.184	14	807.77.621	16	807.81.103	18
807.76.600	148	807.77.199	14	807.77.622	16	807.81.120	17
807.76.601	148	807.77.271	20	807.77.623	16	807.81.121	17
807.76.602	148	807.77.272	20	807.77.624	16	807.81.122	17
807.76.603	148	807.77.273	20	807.77.671	20	807.81.123	17
807.76.610	148	807.77.274	20	807.77.672	20	807.81.200	18
807.76.611	148	807.77.281	14	807.77.673	20	807.81.201	18
807.76.612	148	807.77.282	14	807.77.674	20	807.81.202	18
807.76.613	148	807.77.283	14	807.77.681	14	807.81.203	18
807.76.620	148	807.77.284	14	807.77.682	14	807.81.510	17
807.76.621	148	807.77.340	18	807.77.683	14	807.81.511	17
807.76.622	148	807.77.341	18	807.77.684	14	807.81.512	17
807.76.623	148	807.77.342	18	807.77.796	13	807.81.513	17
807.76.630	148	807.77.360	19	807.77.901	13	807.81.600	18
807.76.631	148	807.77.361	19	807.77.902	13	807.81.601	18
807.76.632	148	807.77.362	19	807.77.903	13	807.81.602	18
807.76.633	148	807.77.391	15	807.77.904	13	807.81.603	18
807.76.690	148	807.77.392	16	807.77.911	15	807.81.710	17
807.76.691	148	807.77.401	13	807.77.912	15	807.81.711	17
807.76.692	148	807.77.402	13	807.77.913	15	807.81.712	17
807.76.693	148	807.77.403	13	807.77.914	15	807.81.713	17
807.76.800	148	807.77.404	13	807.77.921	16	807.81.900	18
807.76.801	148	807.77.411	15	807.77.922	16	807.81.901	18
807.76.802	148	807.77.412	15	807.77.923	16	807.81.902	18
807.76.803	148	807.77.413	15	807.77.924	16	807.81.903	18
807.76.810	148	807.77.414	15	807.77.971	20	807.81.920	17
807.76.811	148	807.77.421	16	807.77.972	20	807.81.921	17
807.76.812	148	807.77.422	16	807.77.973	20	807.81.922	17
807.76.813	148	807.77.423	16	807.77.974	20	807.81.923	17



## INDEX

<b>Item No.</b>	<b>Page No.</b>	<b>Item No.</b>	<b>Page No.</b>	<b>Item No.</b>	<b>Page No.</b>	<b>Item No.</b>	<b>Page No.</b>
808.70.130	34	822.09.331	103	833.71.024	150	843.77.200	142
808.70.131	34	822.09.370	101	833.71.025	150	843.77.900	142
808.70.230	34	822.09.371	101	833.71.027	150	843.81.200	142
808.70.231	34	822.09.372	101	833.71.032	150	843.81.600	142
808.70.630	34	822.09.770	101	833.71.033	150	844.69.220	143
808.70.631	34	822.09.771	101	833.71.034	150	844.69.230	143
808.70.770	34	822.09.772	101	833.71.035	150	844.69.240	143
808.70.771	34	822.09.930	103	833.71.041	150	844.69.630	143
808.70.930	34	822.09.931	103	833.71.042	150	844.69.640	143
808.70.931	34	822.09.970	101	833.71.043	150	845.00.809	145
808.71.001	27	822.09.971	101	833.71.048	150	845.01.300	144
808.71.003	27	822.09.972	101	833.71.049	150	845.01.600	144
808.71.101	27	822.64.033	100	833.71.050	150	845.01.620	145
808.71.103	27	822.99.320	102	833.71.051	150	845.01.806	145
808.71.201	27	822.99.330	102	833.71.056	150	845.02.803	145
808.71.203	27	822.99.340	102	833.71.057	150	845.05.200	144
808.71.301	27	822.99.350	100	833.71.058	150	845.05.300	144
808.71.303	27	822.99.351	100	833.71.059	150	845.05.600	144
808.71.401	27	830.28.700	149	833.71.064	150	845.08.120	144
808.71.403	27	830.28.701	149	833.71.065	150	845.08.220	144
808.71.601	27	830.28.705	149	833.71.066	150	845.08.620	144
808.71.603	27	830.28.706	149	833.71.067	150	845.10.805	144
808.72.000	27	830.28.710	149	833.71.913	150	845.11.802	144
808.72.100	27	830.28.711	149	833.71.914	150	845.12.809	144
808.72.200	27	830.28.720	149	833.71.915	150	846.52.808	144
808.72.300	27	830.28.721	149	833.71.916	150	885.06.209	144
808.72.600	27	830.28.730	149	833.71.917	150	888.00.015	94
808.72.900	27	830.28.731	149	833.71.918	150	888.00.024	94
811.03.000	48	830.28.780	150	833.71.919	150		
811.03.110	48	830.28.781	150	833.74.894	112		
811.03.120	48	830.28.782	150	833.74.913	151		
811.03.301	48	830.28.783	150	833.89.058	151		
811.03.320	48	830.28.786	150	833.89.126	151		
811.03.504	48	830.28.787	150	833.89.134	152		
811.03.513	48	830.28.788	150	833.89.136	152		
811.03.520	48	830.28.790	149	833.89.140	152		
811.03.530	48	830.28.800	149	833.89.141	152		
811.03.800	48	830.28.811	150	833.89.142	152		
811.05.000	49	830.28.812	150	836.21.351	53		
811.05.110	49	830.28.813	150	842.01.909	145		
811.05.500	49	830.28.814	150	842.02.906	145		
811.05.800	49	830.28.815	150	842.34.000	145		
818.83.900	69	830.28.816	150	842.34.010	145		
818.83.910	69	830.28.817	150	842.34.050	145		
818.83.920	69	830.38.810	150	843.63.050	143		
818.83.930	69	833.42.120	105	843.65.600	142		
818.83.940	69	833.42.121	105	843.65.900	142		
822.09.330	103	833.42.122	105	843.77.000	142		

# EASIER TO ACCESS. EASIER TO USE.



WE KNOW YOU'RE ALWAYS ON THE GO AND MAY NOT ALWAYS BE USING A DESKTOP OR LAPTOP TO ACCESS OUR WEBSITE. AND THAT'S EXACTLY WHY OUR SITE HAS BEEN UPDATED WITH YOU IN MIND.

- Improved user experience on any device
- More robust, intuitive navigation
- Updated category displays include more information
- Login and shop on mobile, tablet, desktop or all three!

## STANDARD TERMS AND CONDITIONS OF SALE

All purchases from Häfele America Co. are subject to the Terms and Conditions in effect at the time of shipment. Häfele's Terms and Conditions are set forth on its website, [www.hafele.com/us](http://www.hafele.com/us), and are incorporated herein by reference. Should you not have access to the above web site and wish to obtain a printed copy of the Terms and Conditions, please contact your Häfele Sales Representative and a copy will be sent to you. Prices subject to change or impacted by mandatory tariffs.

# HÄFELE

HAF-CLS-732.98.157

**Häfele America Co.** | 3901 Cheyenne Drive | Archdale, NC 27263

**Phone:** 800 423 3531 | **Fax:** 800 325 6197 | **Showrooms:** New York, Archdale, Los Angeles

[www.hafele.com/us](http://www.hafele.com/us)

© & TM Häfele GmbH & Co KG and/or Häfele America Co. Other trademarks referenced are owned by their respective owners. All rights reserved. Materials, designs and design elements shown herein may be the subject of US and International copyright and other forms of legal protection.